

# RIDLEYBOX<sup>®</sup>



## User Guide

Manual Version 1.17

February 23, 2023



Copyright ©2023 Ridley Engineering, Incorporated. All trademarks are presented once and assumed throughout this document.

RIDLEYBOX®, RIDLEYWORKS® and SPICELaunch® logos are registered trademarks of Ridley Engineering Inc. Unauthorized copies of the RidleyWorks software may not be made. Your copy of RidleyWorks may be used by you on one machine only, and not distributed to others. Any modified, or enhanced versions of RidleyWorks are also protected by this copyright notice. Full details of copyright notice are provided on the software package upon request.

Microsoft® is a registered trademark of Microsoft Corporation

Intel® is a registered trademark of the Intel Corporation.

Picoscope® is a registered trademark of Pico Technology Ltd.

PSIM® is a registered trademark of Powersim Inc.

LTspice® is a registered trademark of Analog Devices Inc.

For assistance, please contact Ridley Engineering directly. We are here to help you.

Ridley Engineering Inc, 725 W. Ventura Blvd , Suite H, Camarillo, CA , USA , 93010

E-Mail: [info@ridleyengineering.com](mailto:info@ridleyengineering.com)

<http://www.ridleyengineering.com>

# Table of Contents

<b>1 Introduction to the RidleyBox</b>	<b>7</b>
1.1 RidleyBox Package Contents	7
1.2 Safety information	8
1.3 Maximum Input Ranges	9
1.4 Grounding	11
1.5 External Connections	11
1.6 Environment	11
1.7 Care of the RidleyBox	12
<b>2 Inside the RidleyBox</b>	<b>13</b>
2.1 What's inside the RidleyBox?	13
2.2 Overview of Inputs and Outputs	14
2.3 RidleyBox Setup	14
<b>3 RidleyWorks Overview</b>	<b>16</b>
3.1 RidleyWorks Features	16
3.2 Working in Levels	17
3.3 RidleyWorks Software Updates	19
3.4 RidleyWorks PSIM and LTspice Links	19

<b>4 PicoScope Overview</b>	<b>20</b>
4.1 PicoScope Hardware Features	20
4.2 PicoScope Software Features	21
4.3 Software Updates	22
<b>5 Making Frequency Response Analyzer Measurements</b>	<b>23</b>
5.1 Starting RidleyWorks and the Frequency Response Analyzer	23
5.2 Frequency Response Analyzer Control Screen	24
5.3 Power Stage Measurement	25
5.4 Sweeping the Power Stage	26
5.5 Comparing the Power Stage Measurement with Predictions	27
5.6 Loop Gain Measurements	28
5.7 Sweeping the Loop	29
5.8 Comparing Loop Gain Measurements with Predictions	30
5.9 Measuring Individual Loop Components	31
5.10 Manually Adjusting Sweep Settings	32
5.11 Advanced Sweep Settings	33
5.12 Visually Adjusting the Source Amplitude Profile	34
5.13 Sweeping a PFC Loop Gain	35
5.13 PFC Loop Gain Example	36
5.14 RC Reference Circuit	37

<b>6 Making Passive Impedance Measurements</b>	<b>38</b>
6.1 High Impedance Measurements	39
6.2 Sweeping Magnetics Impedance	40
6.3 Using RidleyWorks to Analyze Magnetics Data	41
6.4 Sweeping Transformer Leakage Inductance	42
6.5 Low Impedance Measurements	43
6.6 Capacitor Measurement	44
6.7 Comparing Capacitors with RidleyWorks Models	45
6.8 Total Impedance Measurement Range Figure 6.8 shows the combined impedance range for the RidleyBox used in conjunction with our impedance test kit.	46
You can measure below 1 mOhm up to about 70 kHz, and above 1 MOhm up to 1 MHz. This is a combined range of well above 180 dB, more than enough to cover most power components.	46
<b>7 Making Output Impedance and PSRR Measurements</b>	<b>47</b>
7.1 Output Impedance Measurements	48
7.2 Output Impedance Sweep	49
7.3 PSRR Measurement	50
<b>8 Optional Accessory Specifications</b>	<b>51</b>
8.1 High and Low-Impedance Kit	51
8.2 Output Impedance Tester	52
8.3 Ridley Line Injector	53
8.4 Differential Isolation Probes	54

<b>9 RidleyBox Specifications</b>	<b>55</b>
<b>9.1 Frequency Response Analyzer Specifications</b>	<b>55</b>
<b>9.2 Oscilloscope Specifications</b>	<b>56</b>
<b>9.3 Computer Specifications</b>	<b>57</b>
<b>10 Support and Service</b>	<b>59</b>
<b>10.1 Technical Support</b>	<b>59</b>
<b>10.2 Service</b>	<b>60</b>
<b>11 Warranty Information</b>	<b>61</b>
<b>11.1 Limited Warranties</b>	<b>61</b>
<b>11.2 Warranty Exclusions</b>	<b>62</b>

# 1 Introduction to the RidleyBox

Thank you for purchasing the RidleyBox. This is a high-speed expert system for designing and measuring power systems, and the same mobile test system used in teaching our hands-on workshops. The RidleyBox is perfect for engineers on the go—field apps engineers, teaching labs, and working design engineers.

## 1.1 RidleyBox Package Contents



You will find the following items inside your RidleyBox package:

- RidleyBox
- IEC Power Cord
- Four 200 MHz Oscilloscope Probes
- RidleyBox User Guide (on desktop)
- RidleyWorks User Guide (on desktop)
- PicoScope User Guide (on desktop)
- Intel NUC User Guide (on desktop)
- Any optional accessories ordered

**Fig. 1.1: RidleyBox Package Contents**

Your RidleyBox can be used as an oscilloscope, frequency response analyzer, spectrum analyzer, signal generator and logic analyzer. In addition, all of your power supply design essentials are incorporated in the RidleyWorks software included with your RidleyBox.

First, however, let's cover some essential safety information points that are crucial to safe operation of this unique instrument. As the instrument user, your adherence to, and comprehension of these safety warnings are essential before you click the power button and begin setup. When using the RidleyBox, please adhere to the safety warnings whether using as an oscilloscope or a frequency response analyzer.

## 1.2 Safety information

To prevent possible electrical shock, fire, personal injury, or damage to the product, read this safety information carefully before attempting to install or use this product. In addition, follow all generally accepted safety practices and procedures for working with and near electricity.

The oscilloscope within this RidleyBox has been designed and tested in accordance with the European standard publication EN 61010-1 (Safety Requirements for Electrical Equipment for Measurement, Control and Laboratory Use).

Your RidleyBox must be operated on a flat level surface (Such as a bench or table). Do not position the equipment so that it is difficult to operate the disconnecting device (input AC plug). If the equipment is used in a manner not specified by the manufacturer, the protection provided by the equipment may be impaired. Do not replace the detachable AC supply cord with an inadequately rated cord. The RidleyBox is rated 100-240 V $\sim$  (+/- 10%), 1.5 A, 50-60 Hz.

Factory servicing is required in the event of a problem (see warranty information). However, if a qualified person opens the instrument, they first **MUST** disconnect the AC power cord. There are exposed areas of the internal construction that carry the input voltage, and thus will expose the person to hazardous voltages. If the AC cord is re-connected after the instrument is opened, the service person must take care to



identify the hazardous area and take appropriate precautions for themselves and others in the area. We also recommend placing a warning mark near the instrument if it is opened and energized. If the instrument is to be left open, the AC cord must be disconnected to prevent an unqualified person becoming exposed to an electric shock hazard. An insulation test and polarity check must be performed by a qualified person after any service work before the RidleyBox is returned to the end-user. If the AC power cord assembly incorporates a fuse. The fuse must be rated appropriately.

Definitions:

A **WARNING** ⚡ identifies conditions or practices that could result in injury or death.

A **CAUTION** ⚠ identifies conditions or practices that could result in damage to the product or equipment to which it is connected. Refer to this manual if you are unsure of the caution.

The term 'instrument' refers to the RidleyBox and its internal components in the descriptions below.

### 1.3 Maximum Input Ranges

The following table indicates the full-scale measurement range and overvoltage protection range for the instrument. The full-scale measurement ranges are the maximum voltages that can be accurately measured by the instrument. The overvoltage protection ranges are the maximum voltages that will not damage the instrument.

⚡ **WARNING:** To prevent electric shock, do not attempt to measure voltages outside the specified full-scale measurement range:

Full-scale Measurement Range	Overvoltage Protection (DC + AC peak)		
	Input Channels	External Trigger	Signal Generator
± 20 V	± 100 V	± 100 V	± 20 V

 **WARNING:** Signals exceeding the voltage limits in the table below are defined as “hazardous live” by EN 61010-1. This instrument is suitable for connection to voltages that are equal to or less than the EN 61010-1 limits in the table below:

Signal Voltage Limits of EN 61010-1		
± 60 V DC	30 V AC RMS	± 42.4 V pk max

The above EN61010-1 limits apply to any accessory that is not marked with a voltage rating on either connector, cable or body of if a protective finger guard is removed.

 **WARNING:** A signal voltage exceeding the current full-scale measurement rating is detected and indicated on the measurement display of the PicoScope Software screen. A red warning icon will appear in the upper left corner and next to the relevant channel’s vertical axis.

Under these conditions, displayed waveforms and measurements may be incorrect and the condition may be hazardous. Reduce the input sensitivity to achieve a within-range measurement and if the condition persists, to prevent injury or death, disable or otherwise safely disconnect from the source of overvoltage.

 **WARNING:** To prevent injury or death, do not connect the instrument directly to the mains (line power). To measure mains, use only a differential isolation probe that is specifically CAT rated for mains or high-energy use. Appropriate safety training is essential and must be obtained.

 **CAUTION:** Exceeding the overvoltage protection range on any connector can cause permanent damage to this instrument. Ensure that no voltage is present when selecting IEPE Interface Mode, and no voltage is applied when in use.

## 1.4 Grounding

### **WARNING:**

Connect the device to a properly grounded electrical supply through the AC input connector.

The instrument's ground connection through the USB cable is for measurement purposes only.

Never connect the ground input (chassis) to any electrical power source. To prevent personal injury or death, use a voltmeter to check that there is no significant AC or DC voltage between the instrument ground and the point to which you intend to connect it.

 **CAUTION:** Applying a voltage to the ground input is likely to cause permanent damage to the instrument and other equipment.

## 1.5 External Connections

 **WARNING:** To prevent injury or death, use only the power cord and adaptor, if any, supplied with the instrument.

 **WARNING:** Take care to avoid mechanical stress or tight bend radii for all connected leads, including all coaxial leads and connectors. Mishandling will cause deformation and will degrade performance and measurement accuracy.

## 1.6 Environment

 **WARNING:** To prevent injury or death do not use in wet or damp conditions or near explosive gas or vapor.

**⚠ CAUTION:** To prevent damage, always use and store your instrument in appropriate environments.

	Storage	Operating	Quoted Accuracy
Temperature	-20 to +60 °C	0 to 40 °C	20 to 30 °C
Humidity	5 to 95% RH (non-condensing)	5 to 80% RH (non-condensing)	
Altitude	2000 m maximum		
Pollution degree	2 maximum		

## 1.7 Care of the RidleyBox

For details on service, refer to Chapter 9. Your RidleyBox is inspected, tested and approved before being shipped to you. Upon receipt, inspect the instrument and all probes, connectors, cables and accessories before usage for signs of damage.

**⚡ WARNING:** To prevent injury or death, do not use the instrument if it appears to be damaged in any way, and stop use immediately if you are concerned by any abnormal operations.

To prevent electric shock, do not tamper with or disassemble the RidleyBox, case parts, connectors or accessories. This also voids the manufacturer's warranty, as outlined in Chapter 9.

When cleaning the RidleyBox, do not use water. We recommend using isopropyl alcohol cleaning swabs. To prevent electric shock, disconnect all cords and cables first. Do not allow water to enter the casing, as this will compromise the electronics or insulation inside.

**⚠ CAUTION:** Do not block any of the instrument's air vents as overheating will cause damage to the RidleyBox.

Do not insert any objects through the air vents as internal interference will cause damage to the RidleyBox.

## 2 Inside the RidleyBox

Before we begin setup, let's talk about the components contained within the box. This User Manual is designed, by section, to help you achieve results quickly and efficiently. From this manual, we will refer to additional manuals on your desktop that contain more detailed instructions for getting the most from your RidleyBox.

### 2.1 What's inside the RidleyBox?

The RidleyBox is a perfect collection of components ready to move designs and productivity to the next level:

- **RidleyWorks lifetime license** - software for power supply design
- Four-Channel Frequency Response Analyzer controlled by RidleyWorks
- **Ridley Universal Injector** built-in isolator for loop measurements
- **Four-Channel 200 MHz Oscilloscope** controlled by PicoScope 6 Software
- **Intel Computer** with Microsoft Windows lifetime license, Office software and WiFi
- **All Metal RidleyBox RF-Enclosure** for clean measurements in noisy systems



We also recommend Ridley Engineering's optional accessories described in Chapter 8 for other power supply related measurements.

## 2.2 Overview of Inputs and Outputs

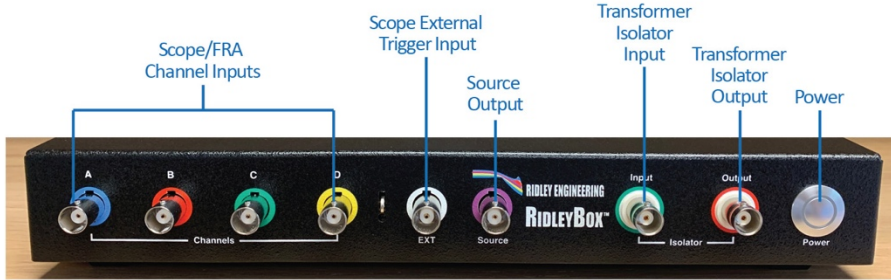

Front View



Rear View

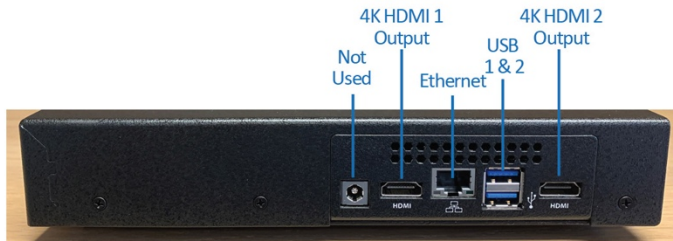

Side View

This diagram describes all input, output and power functions.

Front View: Note that the four channel inputs are used for both oscilloscope and frequency response inputs. The Power button is a soft power button.

Rear View: The Power ON/OFF is a hard power button for disconnecting from the ac line. Use this prior to transporting the device.

Side View: With two HDMI ports, it is possible to connect two 4K monitors for a high-resolution engineering environment.

## 2.3 RidleyBox Setup

To begin setup, connect the following to your RidleyBox:

- IEC Power Cord
- HDMI Monitor (up to 4k resolution) with sound
- USB keyboard
- USB RF mouse

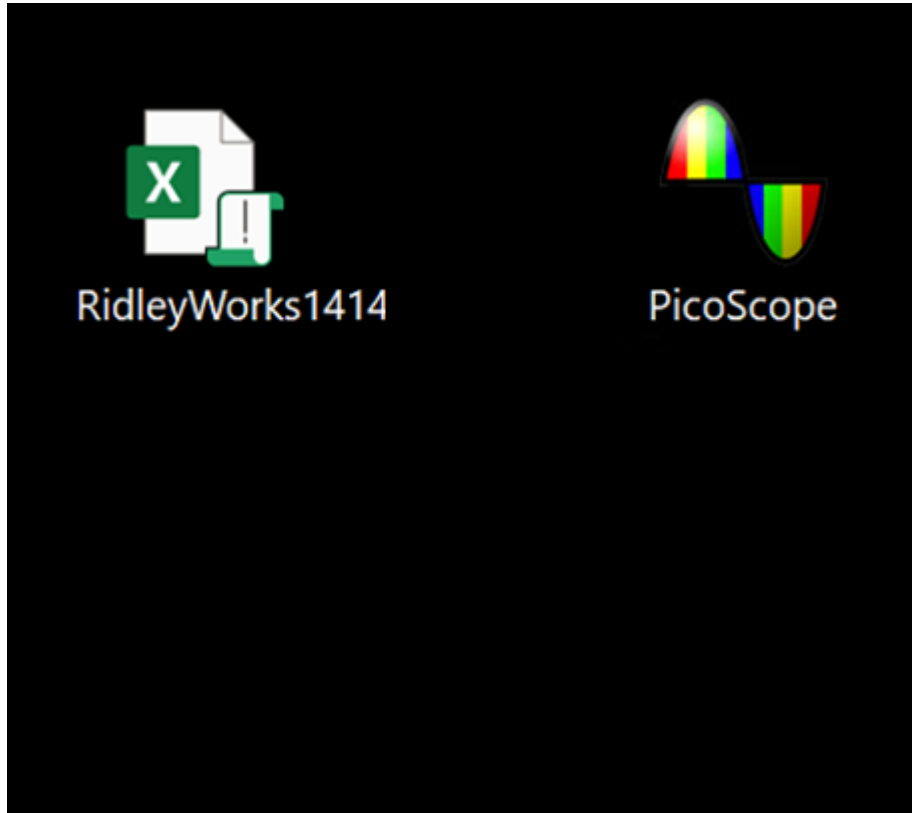

*Fig. 2.2: RidleyBox Primary Software Icons*

Engage the **POWER ON/OFF** rocker switch on the rear of the RidleyBox above the power entry. Then push the **POWER** switch on the front of the RidleyBox to start the on-board computer.

On the monitor, you will see the familiar Microsoft Windows 10 desktop screen. Already loaded on the desktop are Microsoft Office software, RidleyWorks software, PicoScope software, the RidleyBox Manual, RidleyWorks Manual, PicoScope Manual and Intel Nuc Manual.

Open RidleyWorks Software by double-clicking the **RidleyWorks** Icon shown on the left.

## 3 RidleyWorks Overview

### 3.1 RidleyWorks Features

RidleyWorks is the only switching power supply design program which provides component design, large-signal simulation, feedback control design, and small signal analysis in one easy-to-use package. RidleyWorks Release 14 features include:

Power stage designer

**Magnetics designer** (included in full version, not in Control and Simulation version) Library of cores

**12 most popular topologies** used in the industry. All topologies in one program allow you to compare quickly and easily

Industry's **fastest cycle-by-cycle simulation** shows true large-signal performance

**SPICELaunch** instantly creates LTspice files to continue design and more detailed simulation with all components selected

**PSIM Link** instantly creates PSIM schematics for more detailed, high-speed simulation

Unique **LTspice and PSIM circuit models** for proximity loss and core loss

**Control loop designer** suitable for constant-frequency PWM

**Current-mode control** using the latest and most accurate modeling techniques

**Voltage-mode control** using the results of the PWM switch model

**CCM and DCM** converter simulation and analysis

**Small-signal analysis** of control system, including loop gain

Digital compensation delay calculation



Two-stage input filter design and analysis

Output impedance analysis

Audiosusceptibility or **PSRR analysis**

Second-stage LC output filter analysis and design

**Snubber** design and analysis

**Switching loss** analysis for power FETs and IGBTs

Direct Control interface to the AP310 Frequency Response Analyzer

Direct Control Interface to the RidleyBox Frequency Response Analyzer

## 3.2 Working in Levels

There are three levels of application for this software. These levels are commensurate with experience to help you achieve the greatest value from RidleyWorks without the burden of struggling with the **3800+** design equations involved in arriving at the solution.

**Level 1 Basic Design:** At this level, simply input the power requirements for the circuit. Click “OK”, and the entire converter, including control loop, is designed automatically. The components are chosen based on the data. These are working values that can be applied to hardware with confidence. Examine the design with RidleyWorks simulations, or convert designs to LTspice files with the SPICELaunch feature. Use the PSIM link to automatically generate simulation schematics.

**Level 2 Intermediate Design:** Level two designers have design experience and want to input their knowledge as the design progresses. They want to understand and further optimize their design. At this level, look carefully at the selected values from RidleyWorks and change them as needed to improve the design.

**Level 3 Advanced Design:** Level three designers not only know how to design an effective power supply— they know how to get maximum performance out of their power system for very specific applications. They have a library of preferred parts that work well for their applications and use these to fully optimize the design.

The magnetics design section works similarly in levels. View the transformer or inductor on the main design schematic and

- Choose from simplified parameters and refer to a magnetics design house for completion;
- Choose your own cores, wire, and other components and give the completed design to a manufacturer for production; or
- Design the magnetics from the ground up using your own parameters and knowledge.

Regardless of design experience, RidleyWorks provides the ability to check and cross-check all parameters and results. Stop at any time during the process and view resulting waveforms and control parameters.

We hope you enjoy the benefits of this interactive design tool. To learn more about the powerful capabilities of the program, we highly recommend attending one of our [Four-Day Power Supply Design Courses](#).

From the RidleyWorks screen, you can launch the built-in frequency response analyzer for direct flow of live data from measurements. Compare with predictions of performance, design compensators, and to qualify power designs. This will be discussed in Chapter 5.

To engage the power of RidleyWorks for power supply design capabilities, refer to the RidleyWorks Manual on your desktop.

Additional software on the RidleyBox computer includes LTspice XVII and PSIM. RidleyWorks software will automatically generate schematic files for LTspice.

The functionality of PicoScope software, to operate the RidleyBox as an oscilloscope, is explained in more detail in Chapter 4 and the PicoScope Manual on the desktop.

### 3.3 RidleyWorks Software Updates

The latest version of RidleyWorks software is always available for download at <http://ridleyengineering.com/software-ridley/download-RidleyWorks.html>

### 3.4 RidleyWorks PSIM and LTspice Links

RidleyWorks will export schematics to PSIM and to LTspice for further circuit analysis. A license for PSIM is provided with your RidleyBox, allowing you to do very high-speed simulation. It will also allow you to generate Bode plots on the transient circuit model in just a few seconds.

Please see the RidleyWorks manual for details on how to activate these links and run PSIM analysis.

# 4 PicoScope Overview

## 4.1 PicoScope Hardware Features

The PicoScope 5444D, integrated into your RidleyBox, is a high-speed, high-resolution 4-channel oscilloscope. This scope was chosen for our RidleyBox because of the following powerful features:

**High Bandwidth, High Sampling Rate:** The bandwidth, up to 200 MHz, is matched by a real-time sampling rate of 1 GS/s. For repetitive signals, the maximum effective sampling rate can be boosted to 10 GS/s using ETS mode.

**Serial Bus Decoding and Analysis:** The 5444D can decode 1-wire, ARINC 429, CAN and CAN-FT, DALI, DCC, DMX512, Ethernet 10Base-T and 100Base-TX, FlexRay, I<sup>2</sup>C, I<sup>2</sup>S, LIN, Manchester, MODBUS, PS/2, SENT, SPI, UART (RS-232 / RS-422 / RS-485) and USB 1.1 protocol data as standard.

**DeepMeasure:** DeepMeasure delivers automatic measurements of important waveform parameters on up to a million waveform cycles with each triggered acquisition. Results can be easily sorted, analyzed and correlated with the waveform display.

**Waveform Buffer and Navigator:** PicoScope can store the last ten thousand oscilloscope waveforms or spectrum plots in its circular waveform buffer.

**Mask Limit Testing:** Mask limit testing allows you to compare live signals against known good signals, and is designed for production and debugging environments. Use the Buffer navigator to find waveforms that violate the mask.

**Advanced Digital Triggering:** In 1991 Pico pioneered the use of fully digital triggering using the actual digitized data. This technique reduces trigger errors and allows our oscilloscopes to trigger on the smallest signals, even at the full bandwidth. Trigger levels and hysteresis can be set with high precision and resolution.

**FFT Spectrum Analyzer:** The spectrum view plots amplitude against frequency and is ideal for finding noise, crosstalk or distortion in signals. The spectrum analyzer in PicoScope is of the Fast Fourier Transform (FFT) type which, unlike a traditional swept spectrum analyzer, can display the spectrum of a single, non-repeating waveform.

## 4.2 PicoScope Software Features

**Advanced Display:** The software dedicates almost all of the display area to the waveform to seem the maximum amount of data at once. Create a customizable split-screen display, view multiple channels or different views of the same signal simultaneously. Zoom, pan, and filter settings for each wave form.

**Digital Persistence Mode:** Persistence mode superimposes multiple waveforms on the same view, with more frequent data or newer waveforms emphasized with deeper saturation or hotter colors. Use this mode for viewing complex or changing waveforms and you will be able to see glitches even if subsequent waveforms are drawn on top.

**Math Channels and Filters:** With waveform math, select simple functions such as addition and inversion, or open the equation editor to create complex functions involving filters (lowpass, highpass, bandpass and bandstop filters), trigonometry, exponentials, logarithms, statistics, integrals and derivatives. Plot live signals alongside historic peak, averaged or filtered waveforms.

**Custom Probes:** The custom probes feature allows you to correct for gain, attenuation, offsets and nonlinearities in probes, sensors or transducers that you connect to the oscilloscope. For example, it can scale the output of a current probe so that it correctly displays amperes. It can also transform the output of a nonlinear temperature sensor using the table lookup function.

**Alarms:** Program PicoScope to execute actions when it detects events such as mask limit failures, triggers and buffers full. Actions include saving a file, playing a sound, executing a program or triggering the arbitrary waveform generator.

The PicoScope 5444D has many powerful tools to help you acquire and analyze waveforms. While these tools can be used on their own, the real power of PicoScope lies in the way they have been designed to work together.

As an example, the rapid trigger mode allows you to collect 10,000 waveforms in a few milliseconds with minimal dead time between them. Manually searching through these waveforms would be time-consuming, so just pick a waveform you are happy with and let the mask tools scan through for you. When done, the measurements will tell you how many have failed and the buffer navigator allows you to hide the good waveforms and just display the problem ones.

Perhaps instead you want to plot changing duty cycle as a graph? How about outputting a waveform from the AWG and also automatically saving the waveform to disk when a trigger condition is met? With the power of PicoScope the possibilities are almost endless.

Detailed instructions can be found in the PicoScope User Manual located on your desktop.

### 4.3 Software Updates

The latest version of PicoScope software is always available for download at <https://www.picotech.com/downloads>

# 5 Making Frequency Response Analyzer Measurements

## 5.1 Starting RidleyWorks and the Frequency Response Analyzer

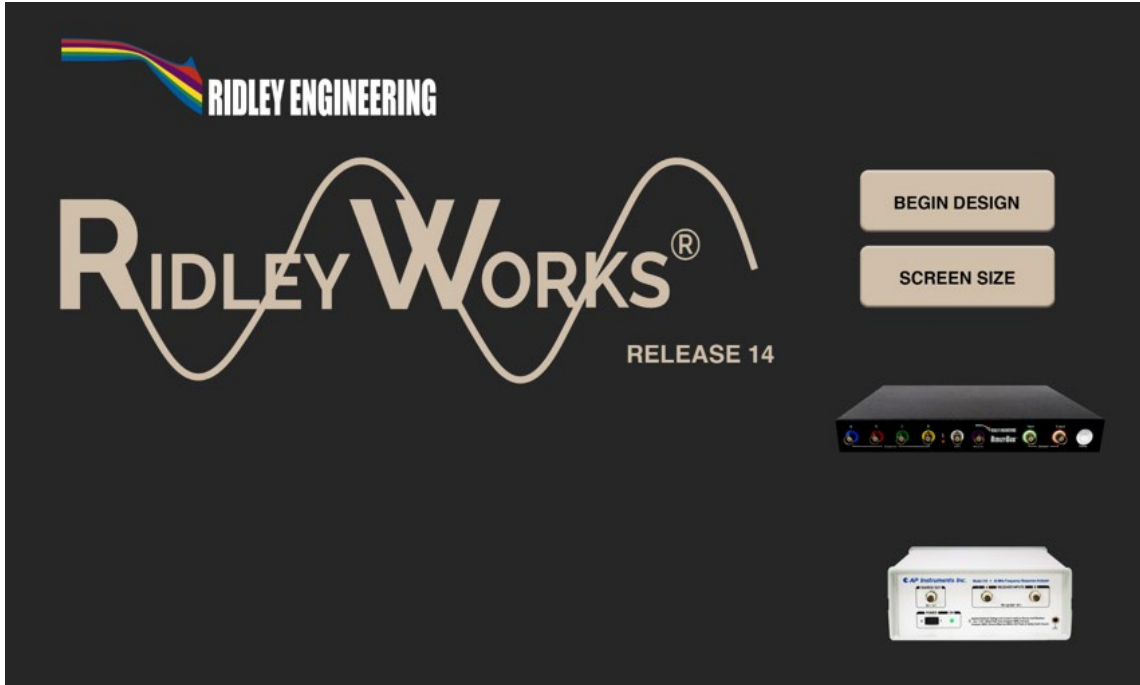

5.1 RidleyWorks Opening Screen with RidleyBox



To start using the RidleyBox as a Frequency Response Analyzer, open RidleyWorks software by double-clicking the **icon** located on the desktop.

This will open RidleyWorks software and the opening screen will appear.

Click **BEGIN DESIGN** if you want to design a switching power supply before making measurements. Please refer to the RidleyWorks User Manual on your desktop for full details and methods for power supply design.

Click on the **RidleyBox** to start measuring

## 5.2 Frequency Response Analyzer Control Screen



Fig. 5.2: RidleyBox FRA Control Screen

The RidleyBox FRA Control Screen will appear. There are multiple preset measurements:

- Plant Transfer Function
- Loop Gain
- Magnetics Inductance
- Leakage Inductance
- 10 Hz to 20 MHz Sweep
- Magnetics Impedance
- PSRR
- Output Impedance
- PFC Loop (click down arrow to show.)
- Low Impedance

Click the RidleyBox **POWER** button on the software screen connect to the Picoscope. The power indicator will turn green. Select the desired measurement. Measurement parameters will then be populated from the design in RidleyWorks.



### 5.3 Power Stage Measurement

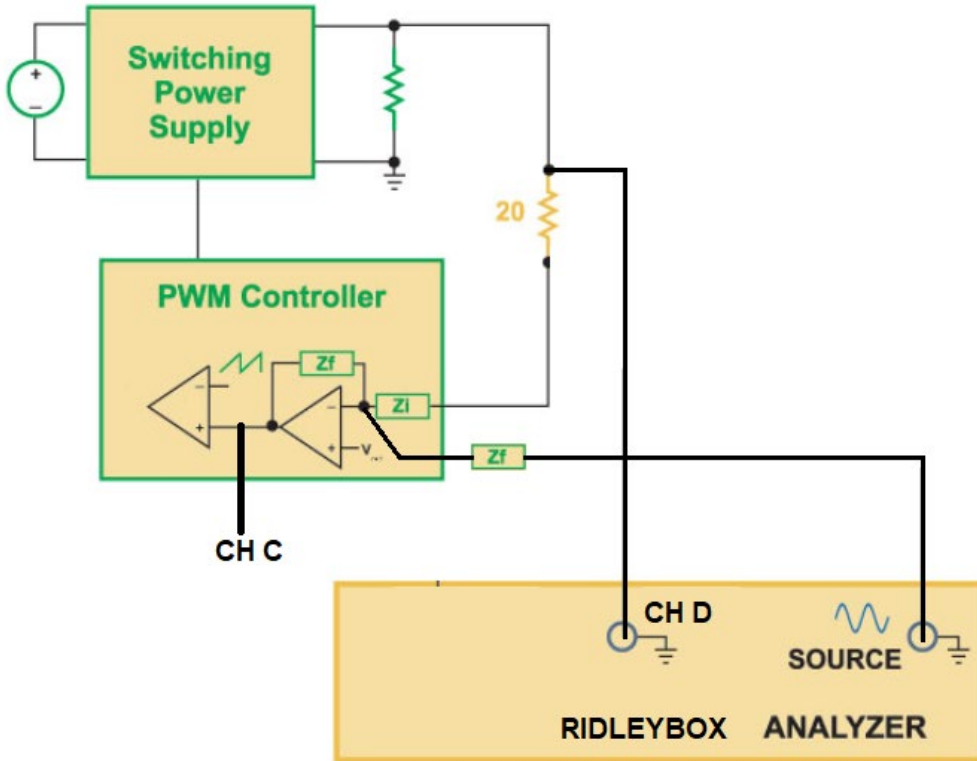

Fig. 5.3: Making a Power Stage Measurement



Click the **PLANT** button to set up the RidleyBox for measuring the Power Stage. This will setup the measurement with a fixed 1 V source, and a 100 Hz bandwidth.

This should be suitable for the relatively low gains that will be encountered in a power stage.

For a frequency response measurement, there are two setup steps: (1) injecting a signal into the circuit and (2) connecting test probes to the appropriate points.

This schematic shows one of the techniques used at Ridley Engineering to measure power stage gain. This is the first step in designing a loop compensator. We use a large capacitor, 1 uF or more, in series with a 100 Ohm resistor for the feedback network.  $Z_f$ .  $Z_i$  is typically just a very large value resistor divider, designed to regulate the output voltage to the correct dc value. The resistor magnitudes are in the order of about 100 k Ohms.

A second impedance branch equal to  $Z_f$  is then connected to the source of the RidleyBox. This gives unity gain from the source to the output of the error amplifier. It also allows a fixed signal size to be used across the entire frequency range.

## 5.4 Sweeping the Power Stage

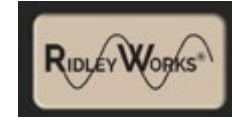
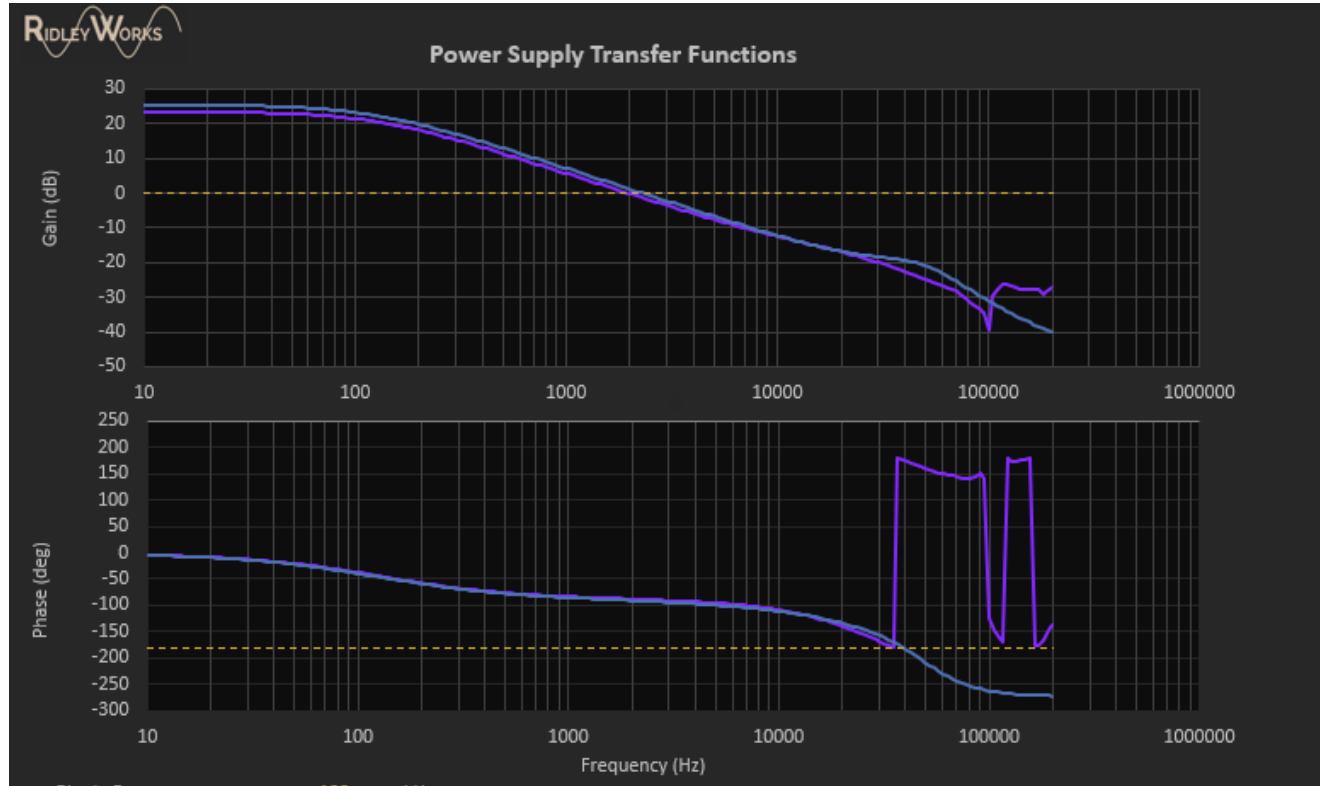

Fig. 5.3: Sweeping the Power Stage

Click the **SWEEP** button to start the measurement. A verbal message indicates that the sweep has initiated. To the right of the RidleyBox logo is a counter that moves incrementally as the sweep progresses. The sweep may be stopped at any time by clicking the **STOP** button.

Each time a sweep is done the new trace will be shown in purple. When the sweep is finished, you will have the option to save the measurement with the **SAVE DATASET** buttons on the screen. Note: always save **DATASET 1** first since this also saves the frequency points.

## 5.5 Comparing the Power Stage Measurement with Predictions



Click the [RidleyWorks](#) button to see the data in the Loop window on the Power Stage sheet of RidleyWorks.

One advantage of the RidleyBox is that the measured data flows straight into RidleyWorks, where it can be compared with predictions.

Verify the performance of your system against the best-available models in the industry.

As you can see from this plot, there will always be differences between measurements and predictions.

Refine models as needed, depending on collected data sets for designs and verification.

**Fig. 5.5: Power Stage Measurement and Prediction**

## 5.6 Loop Gain Measurements

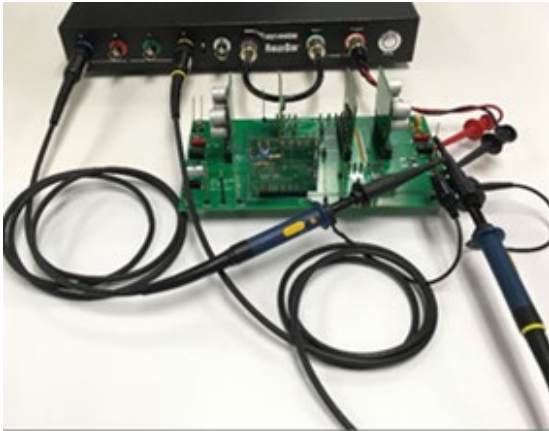
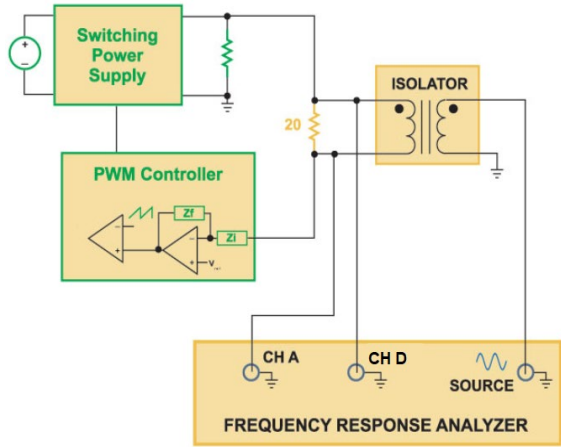

Fig. 5.6: Loop Gain Measurement Setup



Loop gain measurements are fundamental to assuring rugged stability of a system. If you click the **LOOP GAIN** button, a graphic appears showing how to set up the measurement with two probes. The schematic of the measurement setup is also shown. We recommend using Channel D for the Output and Channel A for the Input of the loop.

The sweep frequencies, bandwidth, and signal injection sizes will be automatically set to the right values when you click the loop gain button and should produce a successful loop measurement.

Note: If you are unsure if your loop gain measurement is good, send the measurement screen capture to [info@ridleyengineering.com](mailto:info@ridleyengineering.com) for our engineers to review.

## 5.7 Sweeping the Loop

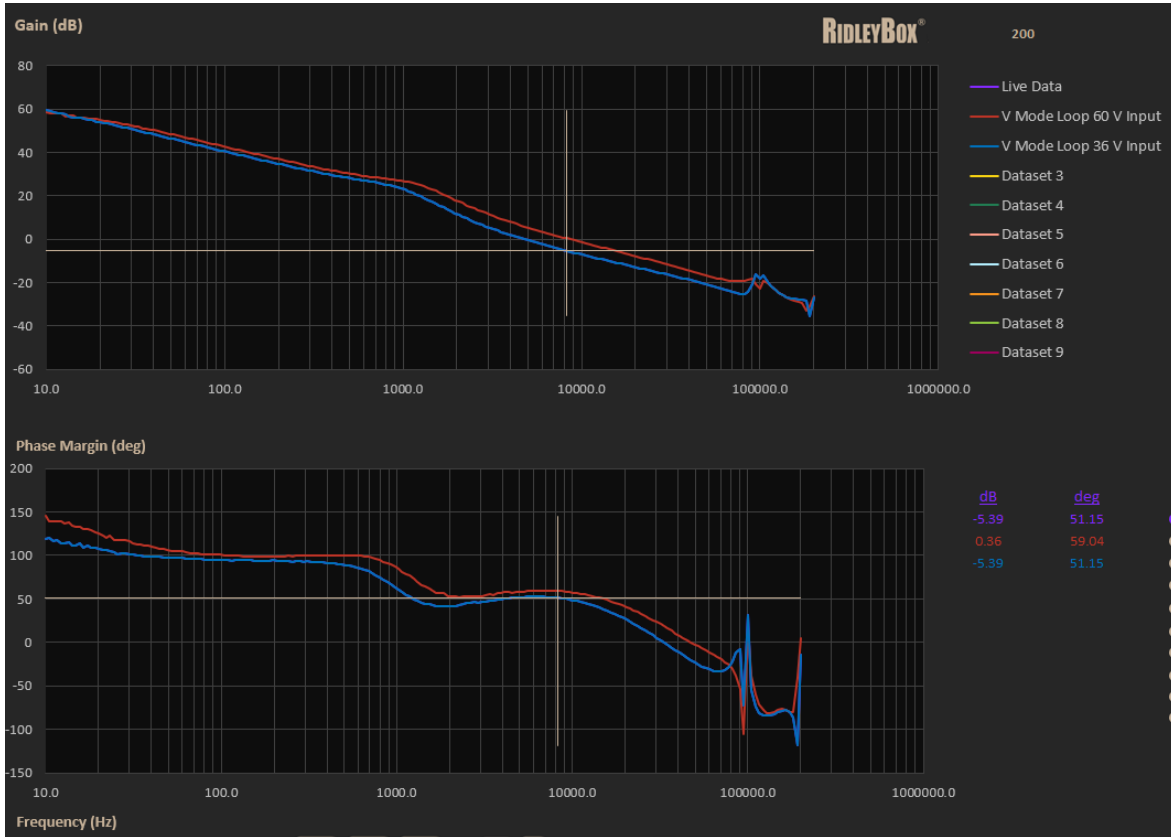
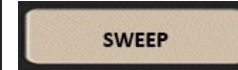

Fig. 5.7: Sweeping the Loop



Click the **SWEEP** button to initiate the measurement.

A verbal message will indicate that the sweep has initiated. The counter to the right of the logo will show the incremental sweep progress. In the example screen capture, the sweep is at point 153 out of 200 points. The sweep may be stopped at any time by clicking the **STOP** button.

Each time the loop is swept, the new trace will be shown in purple. When the sweep is finished, you will have the option to save the measurement with the **SAVE DATASET** buttons on the screen. Two datasets are shown in this figure.

Any of the stored datasets can be individually cleared, or a single **CLEAR ALL** button will remove all traces.

## 5.8 Comparing Loop Gain Measurements with Predictions

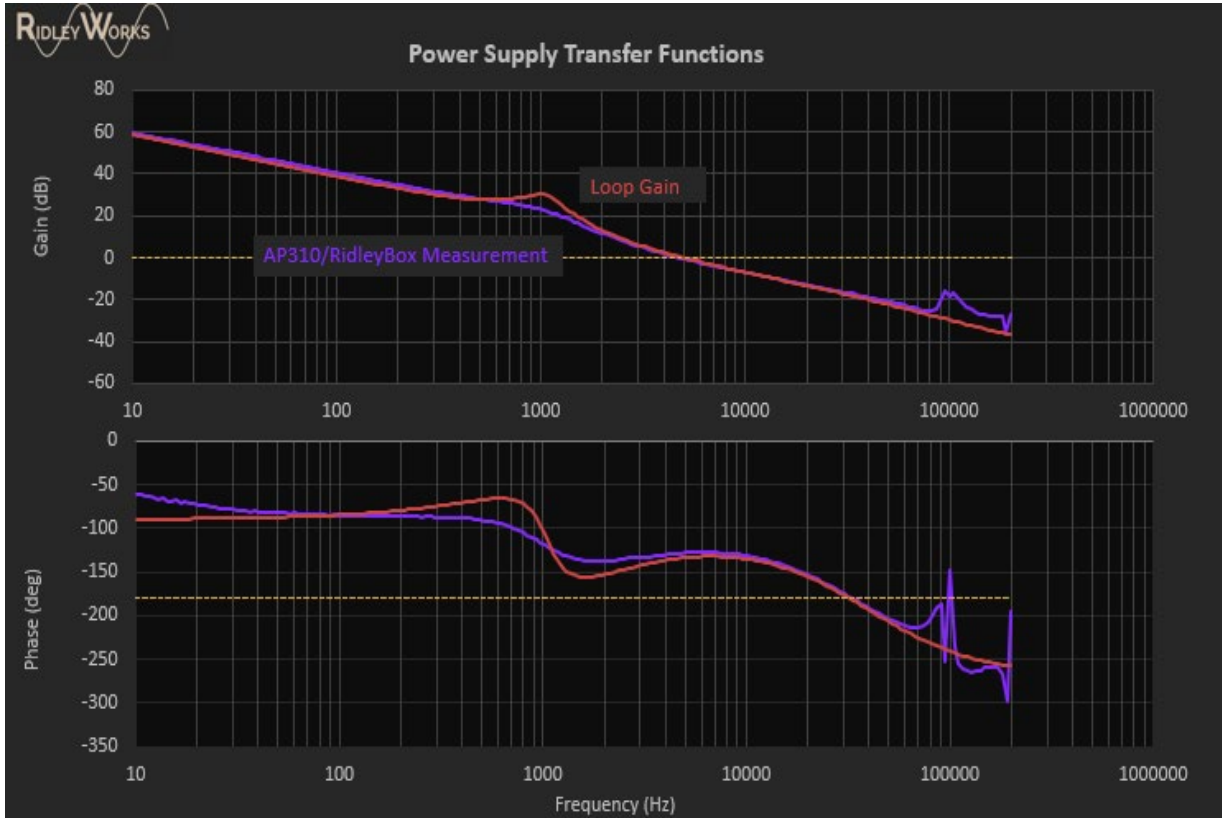

**Fig. 5.8: Viewing Swept Loop Measurements Inside RidleyWorks**



Click the [RidleyWorks](#) button to see the data in the Loop window on the Power Stage design sheet of RidleyWorks . This allows verification of the performance of your system against the best-available models.

There will always be differences between measurements and predictions. That is one of the reasons that bode plot measurements persist in the power electronics industry. Power stages tend to be unpredictable. Controllers operate in high-noise environments. Modeling techniques are always simplifications, and the real-world hardware can be expected to deviate from theory in most cases.

The example shown here is a case where the measurements and predictions are very close – it is unusual to see such good agreement in power systems.

## 5.9 Measuring Individual Loop Components

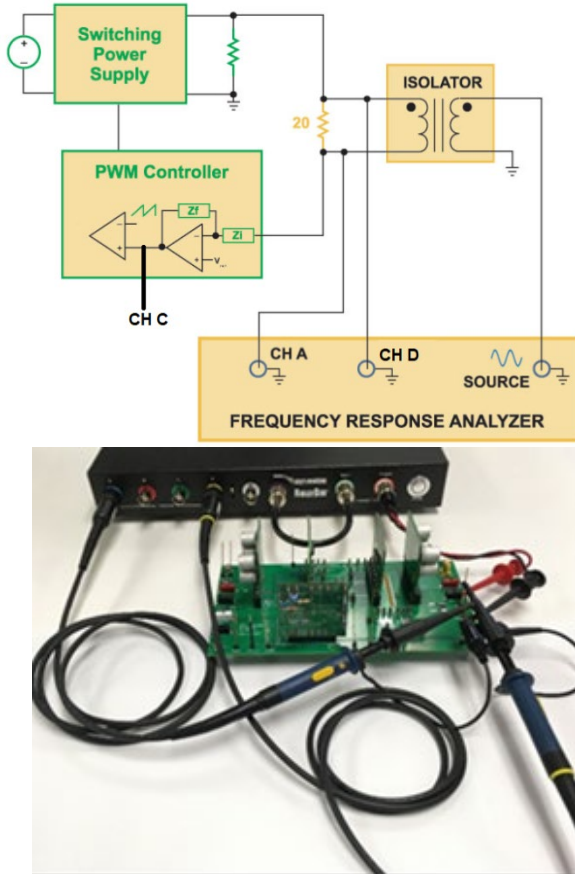

**Fig. 5.9: Measuring Individual Loop Components**

With the same injection technique used for measuring loops, you can use the RidleyBox to measure the Power Stage Gain and the Controller Gain independently. Connect Channel C of the RidleyBox to the output of the error amplifier as shown in the schematic. Three different measurements are possible without moving probes on the circuit by changing the input and output settings for the RidleyBox:

Loop Gain – Input Channel A, Output Channel D

Power Stage – Input Channel C, Output Channel D

Compensator – Input Channel A, Output Channel C

Note that the signal injection is kept as a Variable signal, as it would be for measuring the loop. To change individual input and output settings as needed, please see section 5.10.

## 5.10 Manually Adjusting Sweep Settings

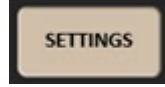
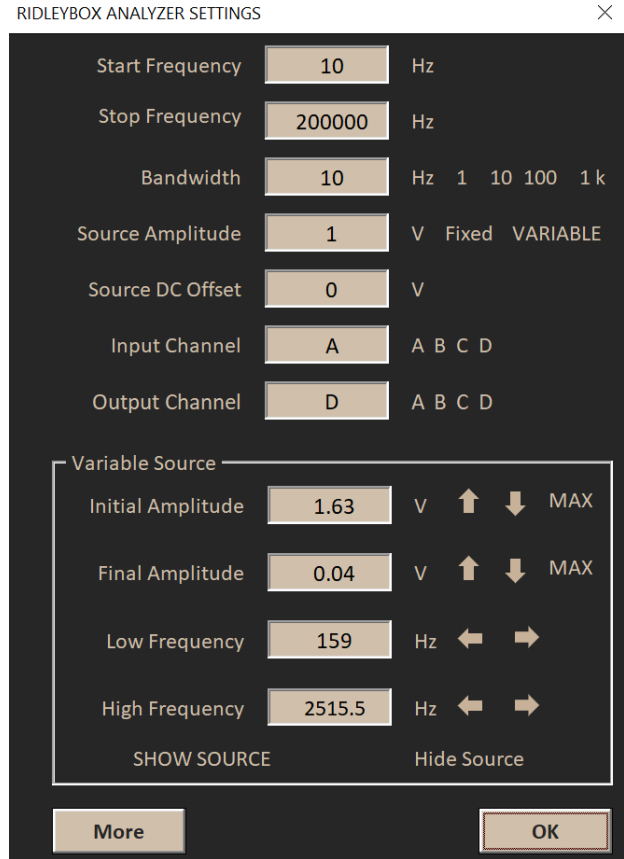

Click the **SETTINGS** button to change the setup of the analyzer. This allows individual adjustment of every parameter.

Start and Stop Frequency – default is from 10 Hz to twice the switching frequency for loop gain measurements.

Bandwidth – default is 10 Hz for loop gain measurements. Lower bandwidths sweep slowly with better noise rejection.

Source Amplitude – a 0-4 V p-p fixed or variable source. Variable source is normally used for a loop gain.

Source DC Offset – zero offset is used for a loop gain

Input Channel – the plotted data is the output/input ratio. Specify any of the four channels.

Output Channel – Channel D/A is the default setting for loop gains.

Variable Source Initial/Final Amplitude – When the Variable Source is selected these initial and final values are used.

Variable Source Low/High Frequency Break Points – This specifies the frequencies at which the source level changes.

**Fig. 5.10: Manual Sweep Setting Adjustments**



## 5.11 Advanced Sweep Settings

Advanced Analyzer Settings

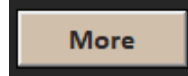
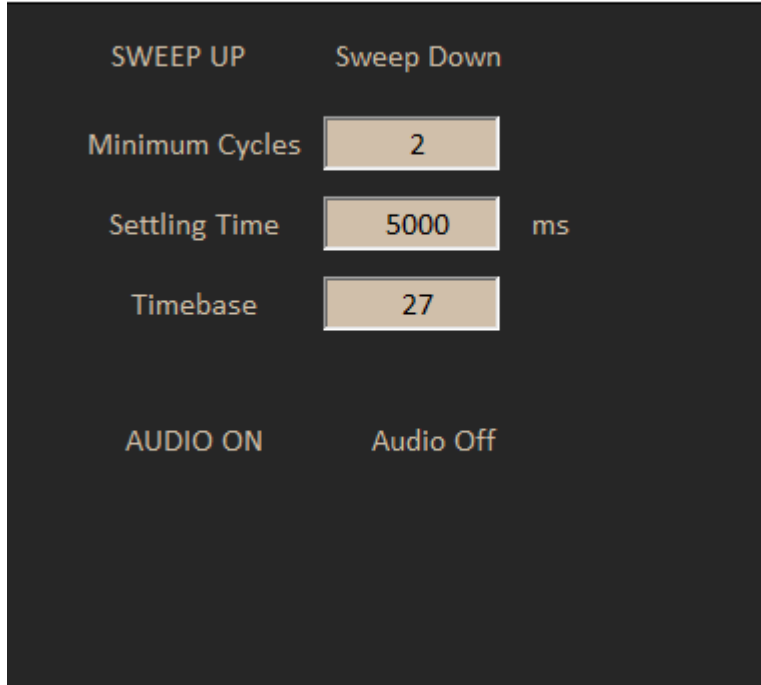

Click the **MORE** button to see additional control settings for the analyzer. A second screen will offer more options:.

**SWEEP UP or Sweep Down** – default is low to high frequency. It may be useful sometimes to reverse the direction of the sweep, especially if you are starting at very low frequencies.

**Settling Time** – It is important that the analyzer allows the circuit to return to steady state after starting each new frequency. Time to achieve that will depend on your control loop design. This value is automatically set depending on which kind of measurement you select. You can experiment with different values if you wish.

**Timebase** – This parameter will be set automatically. Do not change this unless you have experience.

**Minimum Cycles** – This sets the number of cycles for data collection. **Do not change this unless you have experience.**

**AUDIO ON or Off** – by default, the RidleyBox will talk to you if you have sound capability in your monitor. Turn this off if you do not want verbal status notifications.

*Fig. 5.11: Advanced Analyzer Sweep Settings*

## 5.12 Visually Adjusting the Source Amplitude Profile

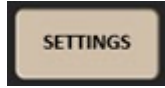
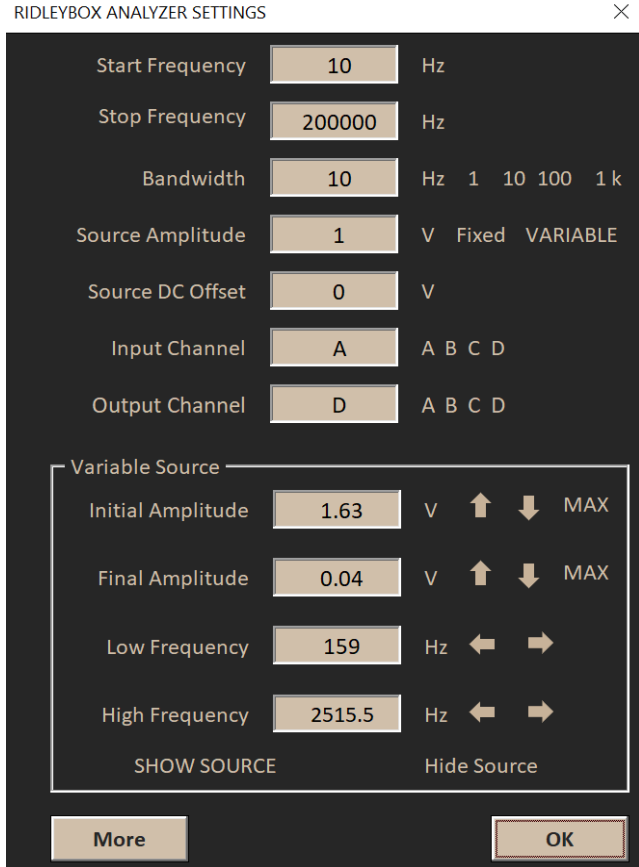

After clicking the **SETTINGS** button, you will see the option to show or hide the source profile. This allows you to see the size of the source versus frequency and to visually adjust it with the controls provided.



The initial and final amplitudes can be adjusted with the Up and Down arrows. It can be visually set anywhere in the range from 0.01 V to 4 V p-p. You can also set the signal size by typing in a number in the corresponding data entry box.



The low and high break frequencies can also be set visually with the left and right arrows that you see.

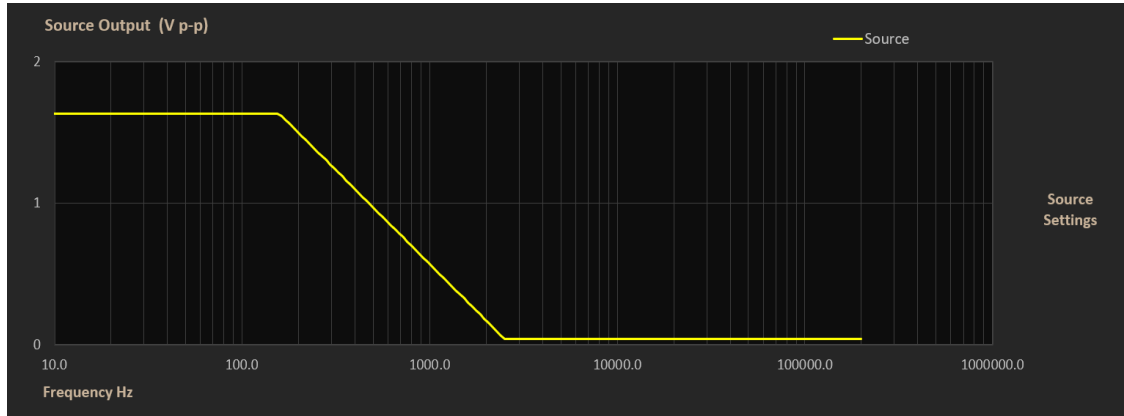

**Fig. 5.12:** Visually Adjusting the Source Profile

### 5.13 Sweeping a PFC Loop Gain

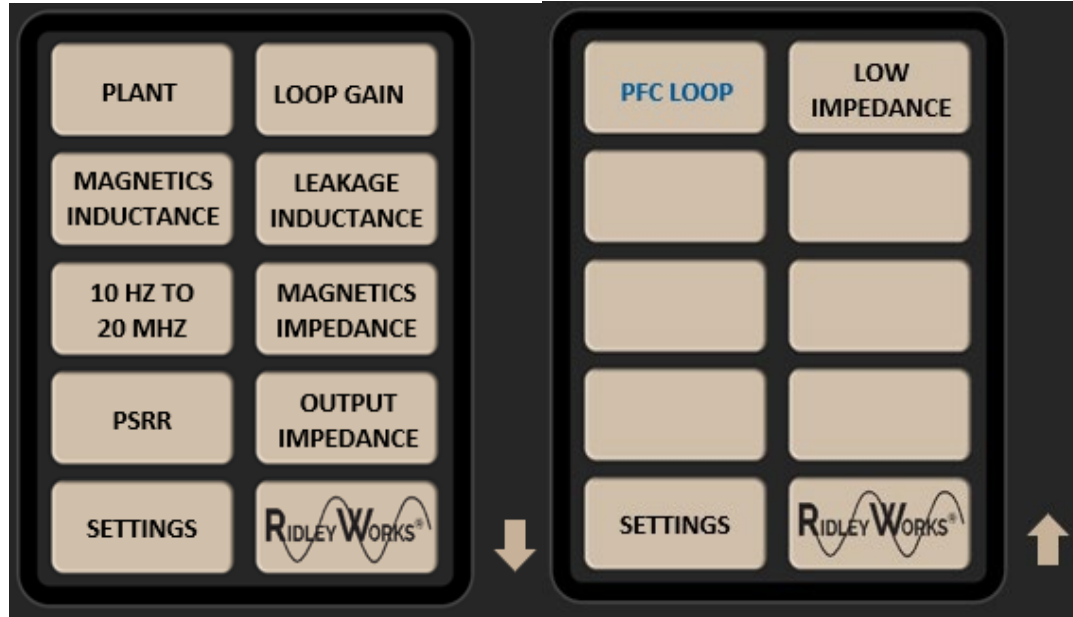

Click the **DOWN** arrow next to the measurement options, and you will see another set of measurement options to choose from. (The **UP** arrow returns you to the previous screen.)

The PFC loop is one of the more challenging measurements to be made with a frequency response analyzer. The crossover frequency of the outer loop is typically set between 1 and 15 Hz. If the loop has a higher crossover frequency, it will affect the distortion. If it is lower, the dynamic response will be poor and the high voltage bus can overshoot dangerously.

Measuring this loop is recommended, even though it is difficult. Once you click on the PFC button, the sweep range will be from 0.1 Hz to 2 kHz . It will take a long time to sweep each point.

Fig. 5.13: PFC Loop Gain Selection

### 5.13 PFC Loop Gain Example

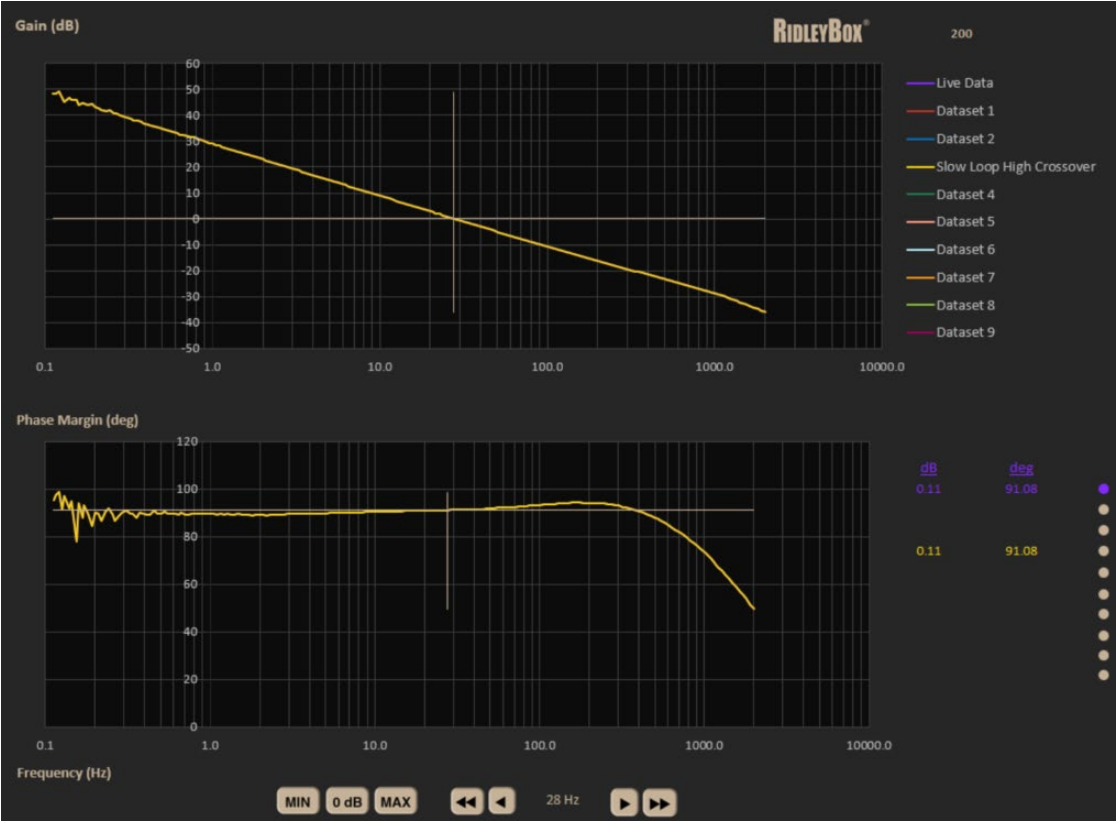

This figure shows a measurement of a low frequency loop, crossing over at 28 Hz. (Very aggressive for a PFC loop gain.)

Notice there is some phase noise in the measurement in the region from 0.1 to 0.2 Hz. This is most likely due to a low frequency bandwidth rolloff in the injection isolator.

Fig. 5.14: Low Frequency Loop Sweep Example

## 5.14 RC Reference Circuit

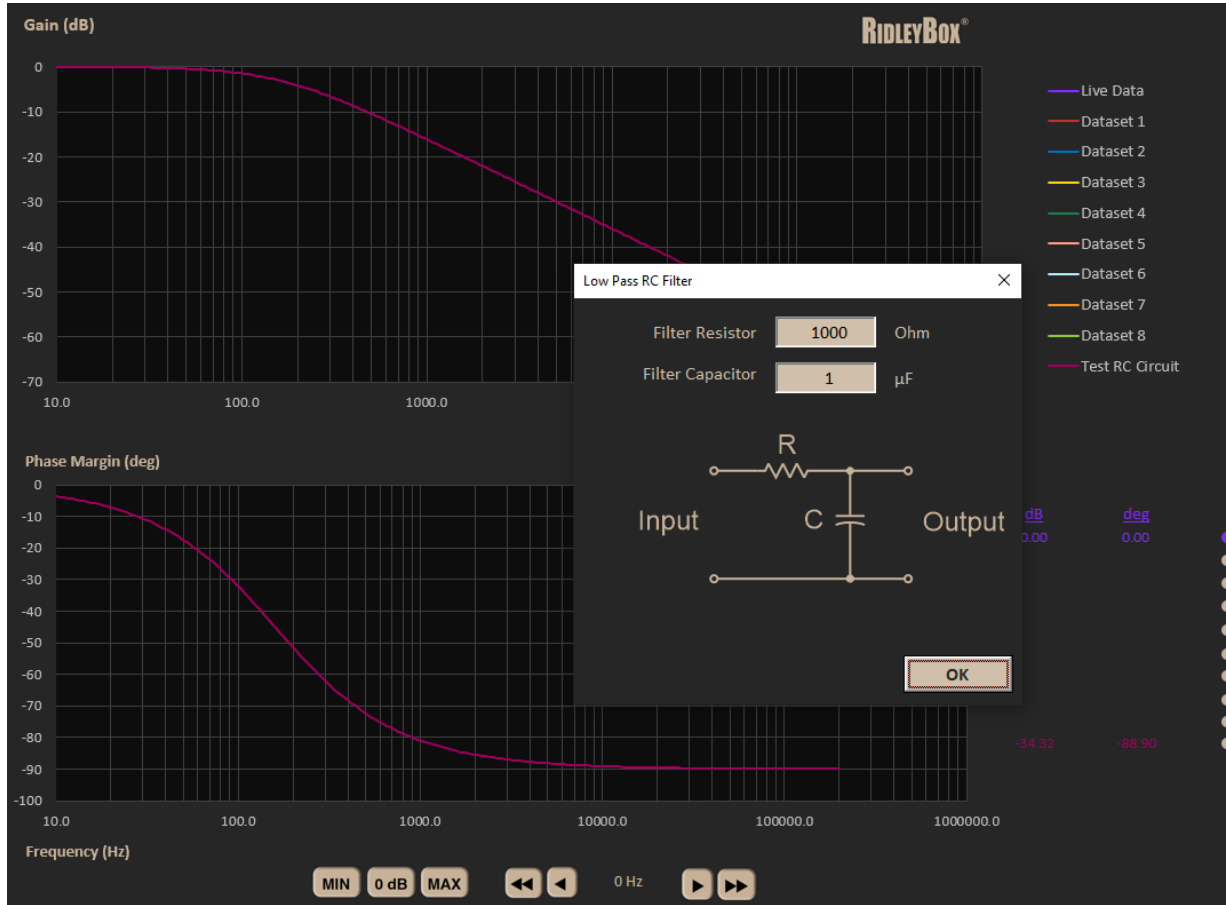
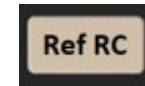

Figure 5.15: Passive RC Network Reference Circuit

If you are doing frequency response analysis for the first time in your career, it can be useful to have a simple RC network to test. The analyzer software provides a reference trace where you can define the component values to test a low-pass filter.



Click on the button to pull up the schematic of the RC network. You can enter your

own component values or use the ones that are predefined for you. Note: data for the RC circuit is stored in **DATASET 9**.

The analyzer source is connected to the input of the circuit and Channel A of the analyzer is connected to the same point. Channel D is connected to the output of the network.



click on the Plant button to set up the measurement parameters, then click on sweep to do the measurement.

## 6 Making Passive Impedance Measurements



*High-Impedance Tester*



*Low-Impedance Tester*

For the measurements in this section, you will need the high and low impedance test kit accessory. Measure the impedance of any unpowered two-terminal device, including inductors, transformers, capacitors and filters. Most of these power parts are poorly specified by manufacturers and proper characterization and testing is recommended before using in your power stage.

The High Impedance Tester will measure accurately from 0.1 Ohm up to more than 100 kOhm (100 dB Ohm). Resolve capacitances as low as 1 pF in magnetics components, which can be crucial for controlling EMI in your power system. The reference resistor in the tester is 1 Ohm.

The Low Impedance Tester measures accurately as low as 1 mOhm from 10 Hz to 100 kHz. Above this frequency, about 2 nH of inductance causes a rise in impedance of the measurement. A four-terminal Kelvin setup is used to obtain these low impedance measurements.

## 6.1 High Impedance Measurements

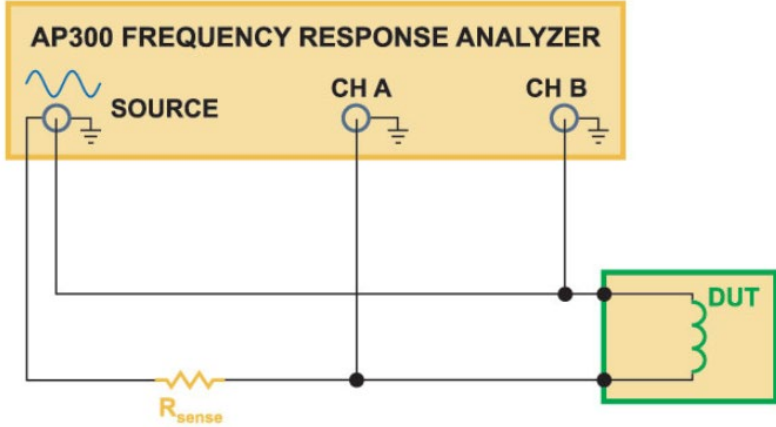

Fig. 6.1: High Impedance Measurements (> 0.1 Ohm)

The three-terminal impedance fixture measures impedances above 0.1 Ohms. Use this test setup for inductors, transformers and small capacitors (as low as 1 pF). This is an essential part of the design and qualification process for custom or standard magnetics components.



To measure transformers or inductors, click the **MAGNETICS IMPEDANCE** button. process for custom or standard magnetics components.

The high impedance tester is connected to Channel A of the RidleyBox and the source is connected to the side. The second terminal is connected to Channel D.

## 6.2 Sweeping Magnetics Impedance

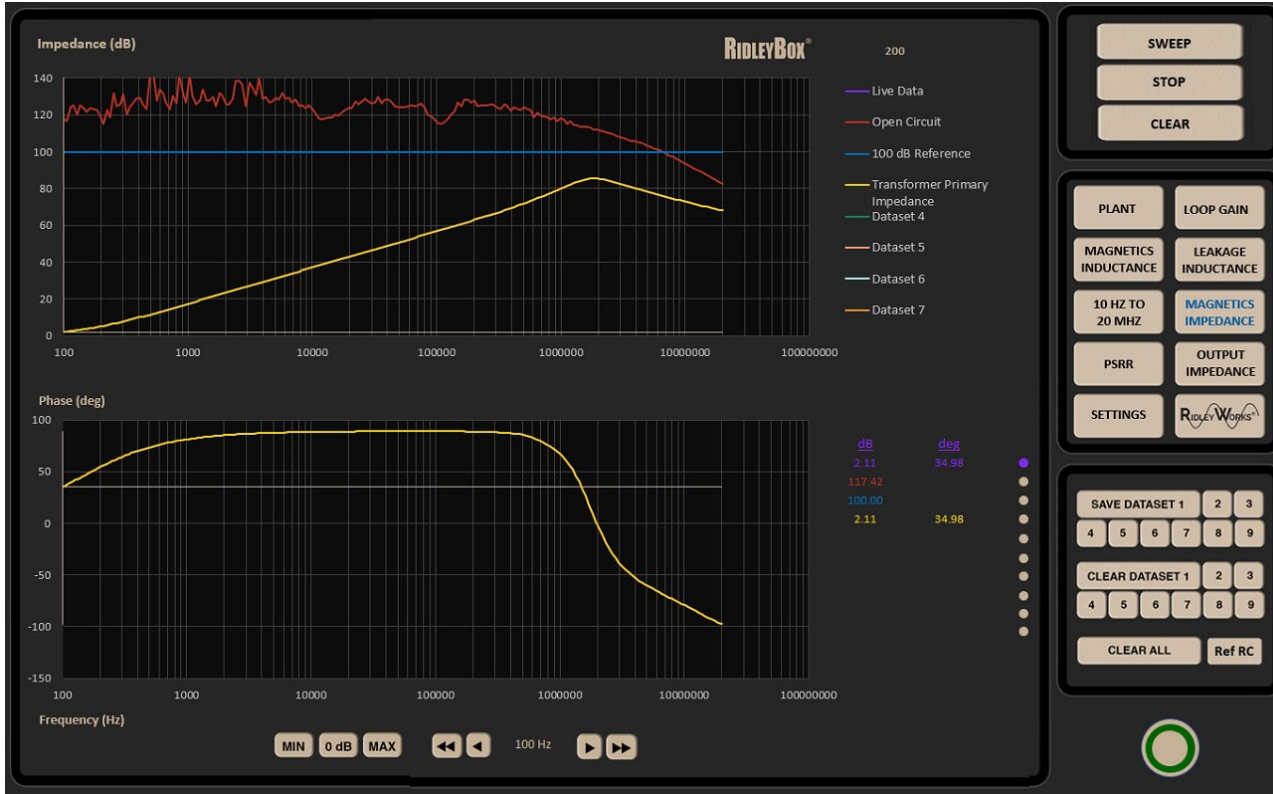

Fig. 6.2: High Impedance Dynamic Range and Transformer Measurement

Here you can see three sets of data for the high-impedance fixture. The red line shows the open-circuit dynamic range, much higher than the 100 dB reference line shown in blue. At around 6 MHz, the curves intersect, corresponding to a capacitance resolution capability of less than 1 pF.

Click the **SWEEP** button to initiate the magnetics impedance measurement.

The yellow trace shows the measurement of a transformer primary winding. In the example, it has a resonance just below 2 MHz.

It is always recommended to measure the magnetics in Gain-Phase mode first. Then, use the **Magnetics Inductance** button, realizing that the inductance reading is only valid below the resonance.



### 6.3 Using RidleyWorks to Analyze Magnetics Data

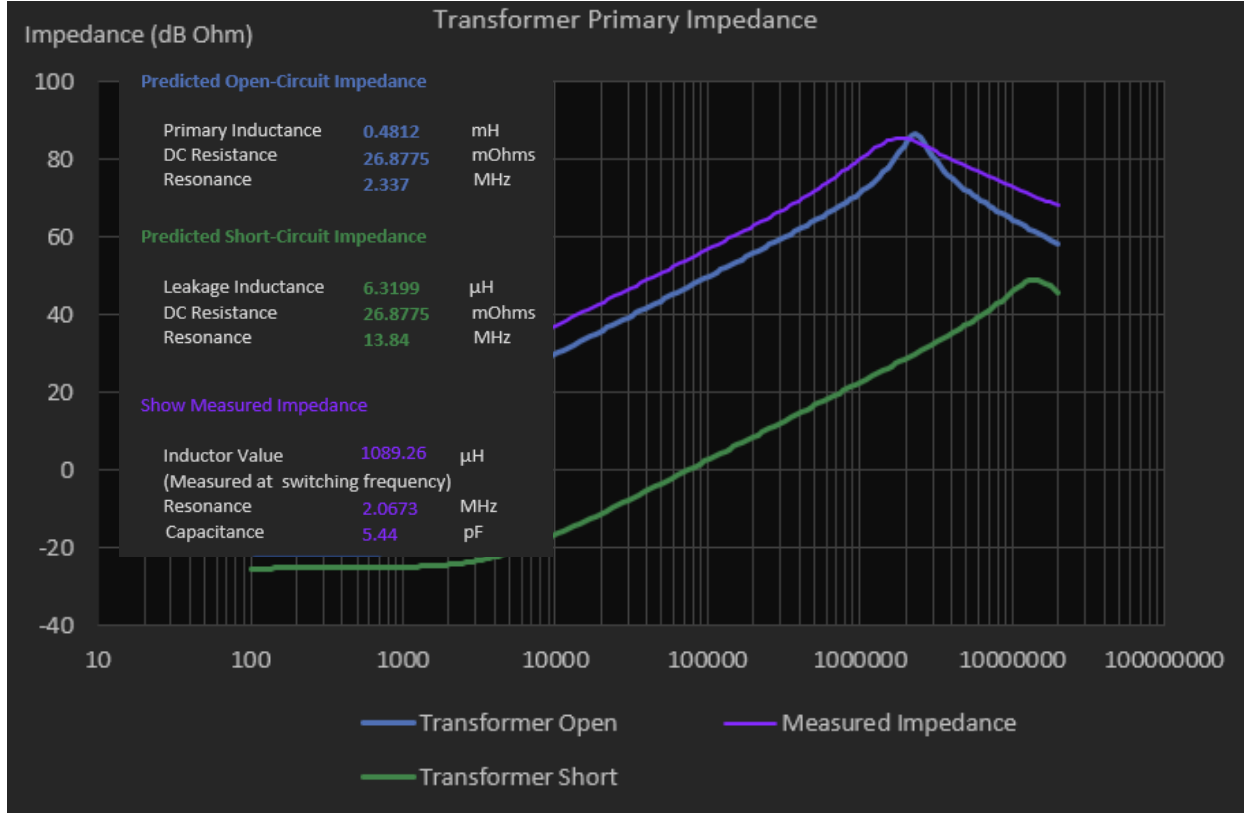

Clicking the **RIDLEYWORKS** button to return to the RidleyWorks program. On

the Transformer Design page, compare predictions of the impedance (based on your design) with the measurements.

RidleyWorks will extract the values of inductance, resonance, and capacitance from the measured data.

For ungapped ferrites, it is quite common to see the measured inductance higher than specified by the manufacturer. Most manufacturers are conservative in their estimates. This should not be a problem when the transformer is placed in the circuit because a higher inductance is usually fine.

A gapped transformer core should be within 5% of the specification for a good-quality manufacturer.

**Fig. 6.3: Transformer Open Circuit Impedance Measurement**

## 6.4 Sweeping Transformer Leakage Inductance



To measure leakage inductance, make sure that the transformer secondary is short-circuited. Connect as before and click the **LEAKAGE INDUCTANCE** button. This starts the sweep at 10 kHz and plots both the impedance of the shorted transformer and the calculated equivalent inductance.

It is quite normal for the leakage inductance to be a function of frequency as shown here, with a substantial drop in value as the frequency increases. This is a sensitive indication of the onset of proximity effect in the windings.

Use this information to more tightly specify the leakage of custom magnetics parts.

Fig. 6.4: Transformer Short-Circuit Leakage Inductance

## 6.5 Low Impedance Measurements

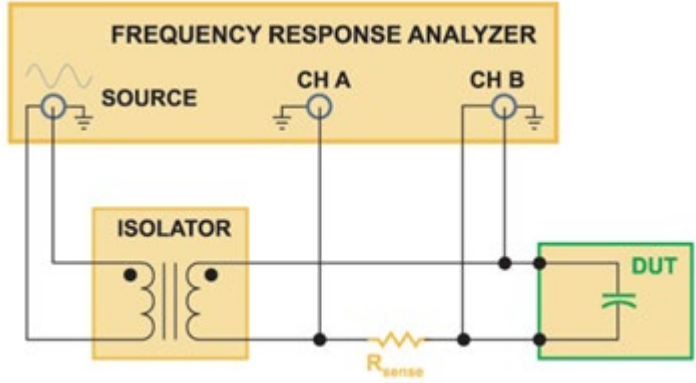

Fig. 6.5: Low Impedance Measurement Setup

The two-terminal, low impedance fixture measures impedances down to 1



mOhm.

To measure large capacitors, or other low impedance devices, click the **LOW IMPEDANCE** button. This is on the second panel of measurement options, accessible after clicking the down arrow.



The low impedance tester is connected to Channel A of the RidleyBox and the isolated source is connected to the second terminal. A pair of minigrabber leads connect to Channel D as shown.

## 6.6 Capacitor Measurement

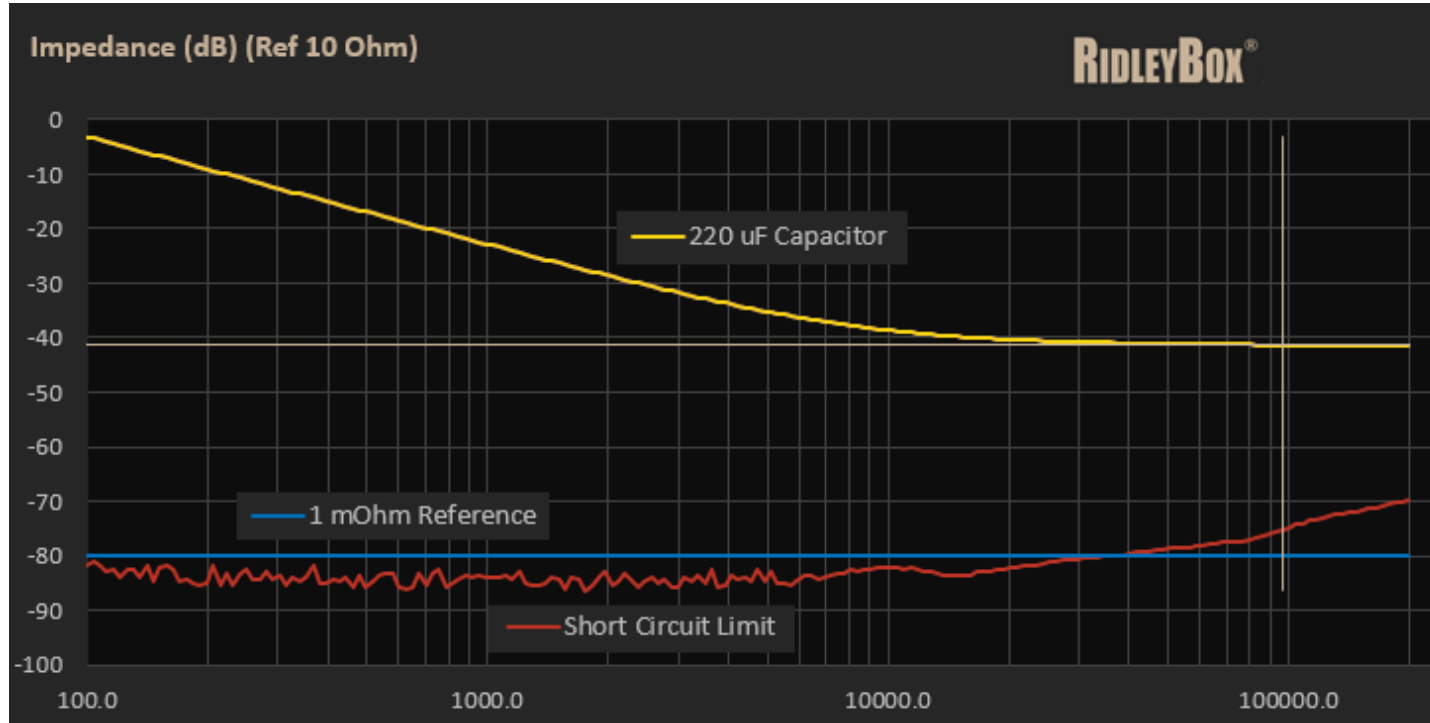

This figure shows the measurement result for a 220 uF capacitor.

A reference 1 mOhm line is shown in blue, and the measurement limitation is shown in red.

While the RidleyBox is useful for this kind of data, it does not work like a balanced bridge. That means that the resolution range is constrained by stray inductances and RF pickup. For most power capacitors, the measurements will be good.

**Fig. 6.6: Example Capacitor Measurement**

## 6.7 Comparing Capacitors with RidleyWorks Models

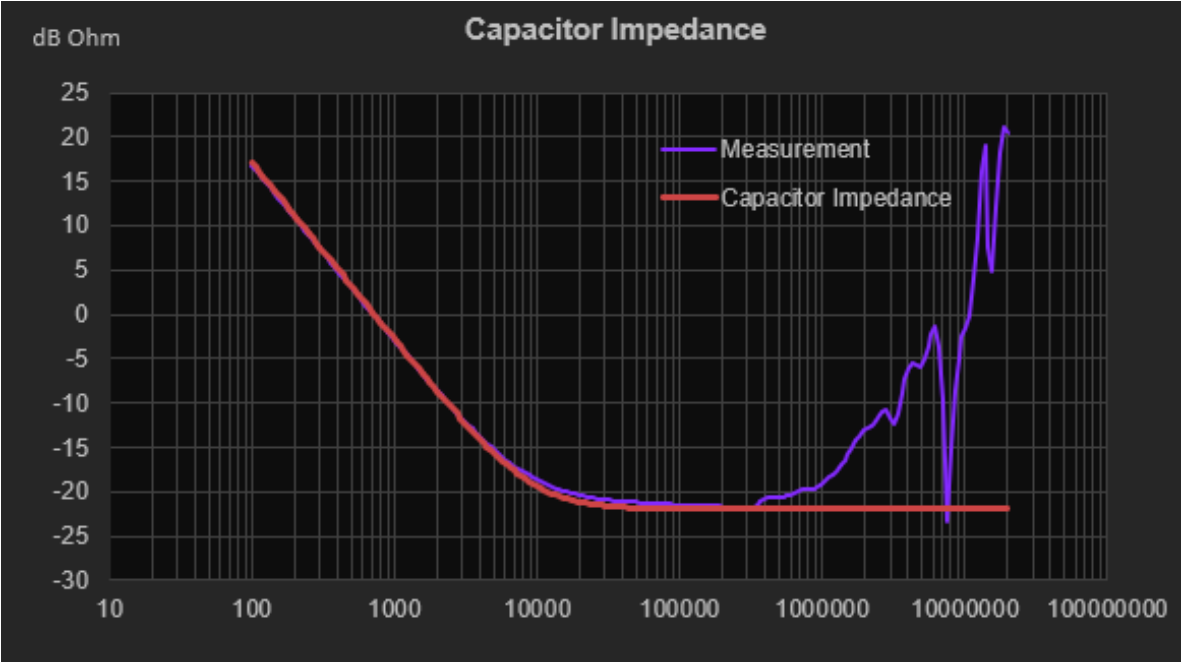

If you click on the [RidleyWorks](#) button, you can compare the measured capacitor impedance with the predicted impedance of the output capacitor.

Notice in this comparison the deviation after 300 kHz. This is due to the inductance of the capacitor and other parasitic elements. There is good agreement with the capacitor value and the ESR value.

**Fig. 6.7: Measured Capacitor Impedance Compared to RidleyWorks Predicted Output Capacitor**

## 6.8 Total Impedance Measurement Range

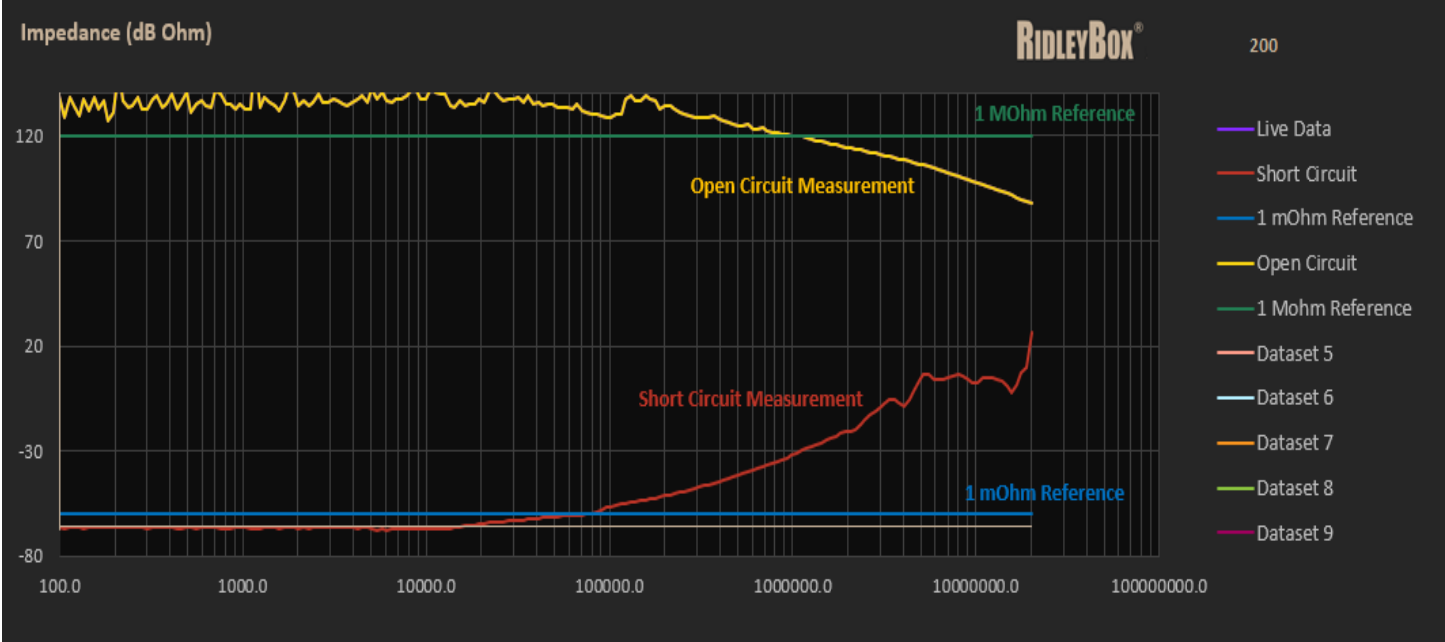

Figure 6.8 shows the combined impedance range for the RidleyBox used in conjunction with our impedance test kit.

You can measure below 1 mOhm up to about 70 kHz, and above 1 MOhm up to 1 MHz. This is a combined range of well above 180 dB, more than enough to cover most power components.

**Fig. 6.8: Combined High and Low Impedance Measurement Capabilities.**

# 7 Making Output Impedance and PSRR Measurements



**Ridley Output Impedance Tester.** For the output impedance measurements in this section you will need the Ridley Output Impedance Tester. This is designed for measuring active power supplies or batteries up to 60 V. It is used to inject a current into the output of the power supply under test, and a reference current output is provided for the impedance measurements.



**Ridley Line Injector.** The Ridley Line Injector is used to add a perturbation signal to the input dc power supply. This is done with an active power device that can support up to 80 V input at 10 A (15 A for short periods, or with the addition of a fan or heatsink). Typical perturbation is about 1 V p-p.

## 7.1 Output Impedance Measurements

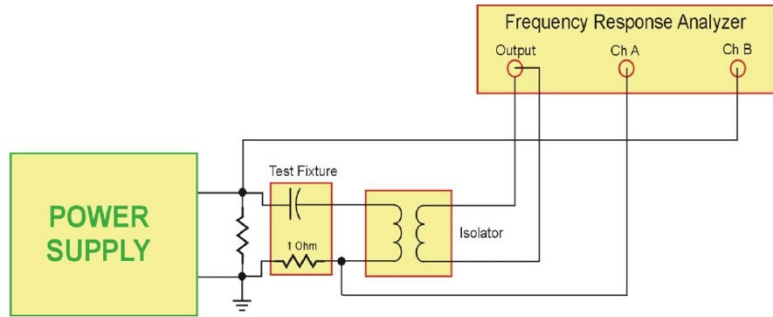

The Ridley Output Impedance Tester is connected as shown here to measure the impedance of an active power supply or battery. This setup establishes a 4-terminal Kelvin connection that can measure impedances below 1 mOhm.



Click the output impedance button to give the right settings for this measurement. The analyzer will use its maximum source level to drive as much current into the output terminals of the power supply as possible.

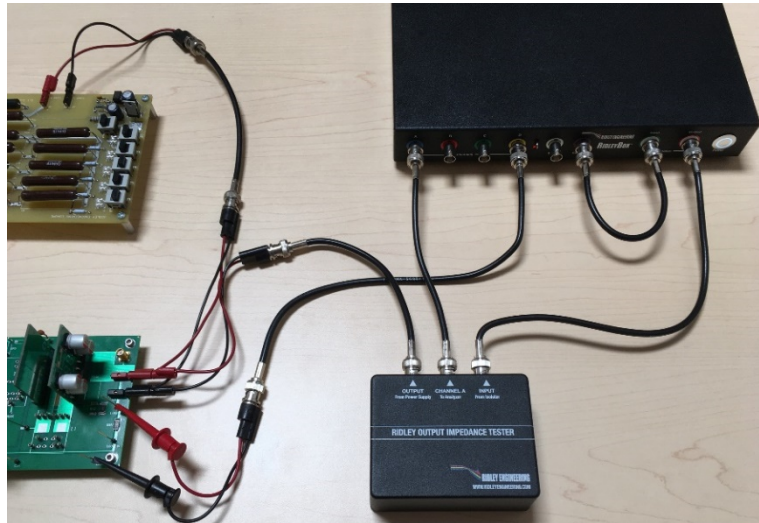

**Fig. 7.1: Power Supply Output Impedance Setup**



## 7.2 Output Impedance Sweep

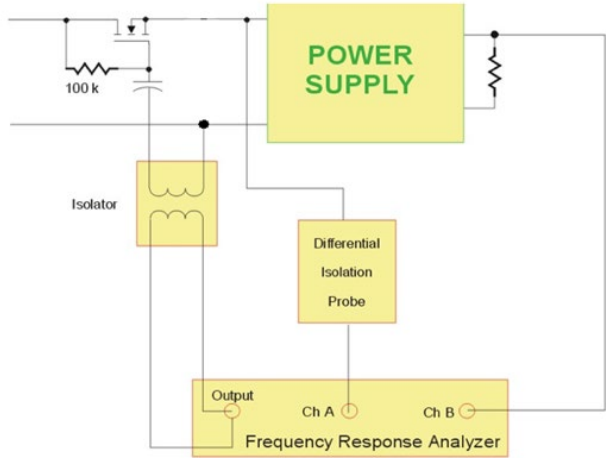

Fig. 7.2: Sweeping the Power Stage Output Impedance

Click the **SWEEP** button to initiate the output impedance measurement. The sweep will start at 10 Hz and finish at twice the switching frequency, by default.

The impedance shown is for a current-mode output stage with just the current loop closed. At low frequency the impedance is equal to the load resistance. At high frequency, the final fixed value is equal to the ESR of the output capacitor on the power supply.

### 7.3 PSRR Measurement



The Ridley Line Injector is connected as shown here to measure the line noise rejection of a power supply.



Click the **PSRR** button to give the right settings for this measurement. The analyzer will use its maximum source level to drive about 1 V into the input of your power converter.

For current-mode systems, the line rejection ratio can be very high (>80 dB) and this can be a challenging measurement to make. It is very important to ground your system properly – contact us if you are having problems with this measurement.

The differential isolation probe is only needed if you have high voltages at the input to your power supply. Otherwise, a 10x scope probe should suffice.

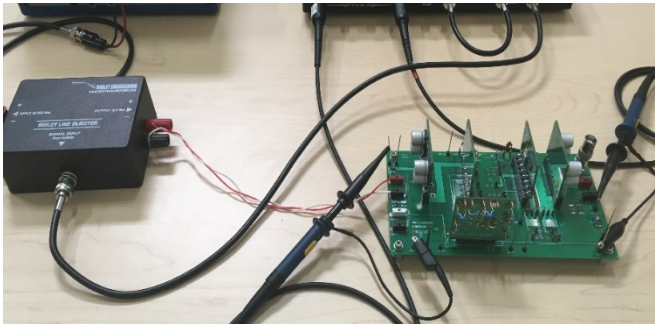

**Fig. 7.3: PSRR Measurement Setup with the Ridley Line Injector**

## 8 Optional Accessory Specifications

### 8.1 High and Low-Impedance Kit



The high and low impedance kit measures the impedance of passive electronic components. This allows characterization of inductors, transformers, capacitors and other passive components.

- Minimum Impedance < 1 mOhm (Low Impedance Fixture)
- Maximum Impedance > 1 MOhm (High Impedance Fixture)
- Minimum Capacitance < 1 pF
- Test Reference High Impedance 1 Ohm
- Test Reference Low Impedance 10 Ohm (Requires isolator for 4-terminal measurement)

## 8.2 Output Impedance Tester



The output impedance tester is designed for measuring impedances of powered circuits and batteries. For example, use it to measure the output impedance of a switching power supply. A four-terminal measurement system is created with this test fixture.

- Minimum Impedance < 1 mOhm
- Maximum voltage of DUT 63 VDC
- Current Sense Test Resistor 1 Ohm

### 8.3 Ridley Line Injector



The Line Injector allows the addition of a perturbation signal to the input rail of a power supply for measuring noise rejection (PSRR) and input impedance.

- Maximum Frequency 1 MHz
- Maximum Signal 1 V typical (capacitive-load dependent)
- Maximum Input Voltage 80 VDC
- Maximum Load Current 10 A (15 A with Heatsink or Fan)
- Typical Voltage Drop 1 VDC input to output

## 8.4 Differential Isolation Probes



These probes are used to provide full safety isolation for measuring high-voltage and high-power circuits.

- Bandwidth: DC to 25 MHz
- Isolation: 1000 Vrms Cat III
- Attenuation: 1/20 or 1/200
- Output: Max +/-7 V BNC 50 Ohm Impedance
- Input: High-Voltage Safety Probes 4 MOhm 5 pF
- Power: Four AA Batteries

All of these accessories are available to purchase on our website at <https://shop.ridleyengineering.com/collections/hardware>

# 9 RidleyBox Specifications

## 9.1 Frequency Response Analyzer Specifications

Minimum Sweep Frequency	0.1 Hz
Maximum Sweep Frequency	20 MHz
Output Signal Amplitude	0 to 4 V p-p
Source Output Impedance	50 Ohm Fixed
Transformer Isolated Output	3:1 Step Down, 0.1 Hz to 20 MHz. 240 VAC functional isolation, maximum input 10 VAC pk-to-pk, 100 mA
Dynamic Range (Passive Components)	>100 dB typical
Dynamic Range (Active Switching Circuits)	>70 dB typical
Test Channels	4
Measurement Bandwidth	1 Hz to 1 kHz
Maximum Signal Input	20 VDC (1x probe), 200 VDC (10x probe)
Stored Measurement Traces	10 Standard (Can Be Increased Upon Request)
Measurement Sweep Time	1 Hz BW < 300 seconds 10 Hz BW Hz < 55 seconds 1 kHz BW <25 seconds (10 Hz to 200 kHz 200 points)
Input Channels	Grounded to Chassis
Data Interface	All data flows directly into Excel, can be copied and pasted into any other Windows program

## 9.2 Oscilloscope Specifications

Analog Input Channels	4
Input Type	Single-ended, BNC(f) Connector
Bandwidth (-3 dB)	200 MHz
Rise Time (calculated)	1.75 ns
Bandwidth Limiter	20 MHz, selectable
Vertical Resolution	8, 12, 14, 15 or 16 bits
LBS Size (quantization step size)	8 bit mode: <0.6% input range; 12-bit mode: <0.04% input range; 14-bit mode: <0.01% input range; 15-bit mode: <0.005% input range; 16-bit mode: <0.0025% input range
Enhanced Vertical Resolution	Hardware resolution + 4 bits
Input Ranges	± 10 mV to ± 20 V full scale, in 11 ranges
Input Sensitivity	2 mV/div to 4 V/div (10 vertical divisions)
Input Coupling	AC/DC
Input Characteristics	1 MΩ ± 1%    14 ± 1 pF
Gain Accuracy	12 to 16-bit modes: ± 0.5% of signal ± 1 LSB; 8-bit mode: ± of signal ± LSB
Offset Accuracy	± 500 μV ± 1% of full scale
Analog Offset Range	± 250 mV (10, 20, 50, 200 mV ranges); ±2.5 V (500 mV, 1 V, 2 V ranges); ± 20 V (5, 10, 20 V ranges)
Analog Offset Control Accuracy	± 0.5% of offset setting, additional to basic DC offset accuracy
Overvoltage Protection	± 100 V (DC + AC peak)

Additional specifications can be found in the PicoScope Manual on your desktop.



## 9.3 Computer Specifications

Processor	Intel® NUC Board NUC7i5DNBE has a soldered-down 7 <sup>th</sup> generation Intel® Core™ i5-7300U dual-core processor with up to 15 W TDP
Memory	Two 260-pin 1.2 V DDR4 SDRAM Small Outline Dual Inline Memory Module (SO-DIMM) sockets <ul style="list-style-type: none"> <li>— Support for DDR4 1866/2133 MHz SO-DIMMs</li> <li>— Support for 4 Gb and 8 Gb memory technology</li> <li>— Support for up to 32 GB of system memory with two SO-DIMMs using 8 Gb memory technology</li> <li>— Support for non-ECC memory</li> <li>— Support for 1.2 V low voltage JEDEC memory only</li> </ul> 16 GB DDR4 RAM Added
Graphics	Integrated graphics support for processors with Intel® Graphics Technology <ul style="list-style-type: none"> <li>— Two High Definition Multimedia Interface* 2.0a (HDMI*) back panel connectors</li> <li>— Flat panel displays via the internal Embedded DisplayPort* 1.4 (eDP) connector</li> </ul>
Audio	Intel® High Definition (Intel® HD) Audio via the HDMI v2.0a interface through the processor
Storage	SATA ports: <ul style="list-style-type: none"> <li>— One SATA 6.0 Gb/s port (blue)</li> <li>— One SATA 6.0 Gb/s port is reserved for an M.2 2280 module</li> </ul> 256 GB SSD Added
Peripheral Interfaces	2x USB 3.0 ports 2x HDMI CEC ports (4K resolution compatible)
BIOS	Intel® BIOS resident in the Serial Peripheral Interface (SPI) Flash device Support for Advanced Configuration and Power Interface (ACPI), Plug and Play, and System Management BIOS (SMBIOS)
LAN	Gigabit (10/100/1000 Mb/s) LAN subsystem using the Intel® I219LM Gigabit Ethernet Controller

Hardware Monitor Subsystem	<p>Hardware monitoring subsystem, based on ITE Tech. ITE8987E-VG embedded controller, including:</p> <ul style="list-style-type: none"> <li>Voltage sense to detect out of range power supply voltages</li> <li>Thermal sense to detect out of range thermal values</li> <li>One processor fan header</li> <li>Fan sense input used to monitor fan activity</li> <li>Fan speed control</li> </ul>
Wireless	<p>Intel® Dual Band Wireless-AC 8265</p> <ul style="list-style-type: none"> <li>— 802.11ac, Dual Band, 2x2 Wi-Fi + Bluetooth v4.2</li> <li>— Maximum Transfer speed up to 867 Mbps</li> </ul> <p>Supports Intel® Smart Connect Technology</p>
Intel® vPro Technologies	<ul style="list-style-type: none"> <li>Intel® Active Management Technology (Intel® AMT) 11.6</li> <li>Intel® Virtualization (Intel® VT-x)</li> <li>Intel® Virtualization for Directed I/O (Intel® VT-d)</li> <li>Intel® Trusted Execution Technology (Intel® TXT)</li> <li>Intel® Identity Protection Technology (Intel® IPT)</li> <li>Intel® Software Guard Extensions (Intel® SGX)</li> <li>Intel® Transparent Supply Chain (Intel® TSC)</li> <li>Trusted Platform Module (TPM) 2.0</li> </ul>

Additional specifications can be found in the Intel Nuc Manual on your desktop.

# 10 Support and Service

## 10.1 Technical Support

Customer Support is provided by email, phone, and direct remote interface from Ridley Engineering.

If you are having issues with the setup or functions of the RidleyBox—or any associated software installed by Ridley Engineering, please call or e-mail for help. If no one is immediately available, please leave a message, including your name and phone number, and your call will be returned as soon as possible. You can attach your file to an email for assistance.

Phone: (US) 805 504 2212

E-Mail: [info@ridleyengineering.com](mailto:info@ridleyengineering.com)

(UK) +44 (0)1509 276 245

Your Ridley Engineering technician may request to access your RidleyBox by remote interface. With instructions over the telephone or by email, granting access with a unique identifier will help us look at and diagnose most issues. It will also help us determine which hardware or component inside your RidleyBox may be functioning improperly.

**Group Support on Social Media:** We recommend joining our Facebook and LinkedIn groups to discuss techniques and additional technical information regarding RidleyBox, PicoScope and RidleyWorks functionality: **POWER SUPPLY DESIGN CENTER** on Facebook and LinkedIn.

**Ridley Engineering Design Center:** To view hundreds of educational tutorials, webinars, design tips and articles – visit **RIDLEY ENGINEERING'S DESIGN CENTER** at <http://www.ridleyengineering.com/design-center-ridley-engineering.html>

## 10.2 Service

No hardware parts within the RidleyBox are user-serviceable items. Breaking the tamper-resistant seal will void the manufacturer's warranty if opened by anyone other than a Ridley Engineering licensed technician. For Warranty information, please refer to Chapter 11.

Repair, servicing and adjustment require specialized equipment and trained technicians and must only be performed by Ridley Engineering. If your RidleyBox needs to be returned for service, your Ridley Engineering Technician will provide an Authorization Number with instructions for return. Following these return instructions are especially important for units returning from outside the USA . All RidleyBox units are serviced only by our licensed technicians in Camarillo, California:

Ridley Engineering Inc.  
725 W Ventura Blvd, Suite H  
Camarillo, CA 93010

At Ridley Engineering, we assist with diagnostics and repair of all the components within the instrument. If we cannot repair it, and it is within warranty without signs of abuse or improper usage, we will replace it. In the event of improper usage or evidence of abuse, a quote will be rendered for standard repair charges or replacement charges.

In the event that servicing is required of the PicoScope Oscilloscope hardware, this component will be extracted by our technician and sent to Pico Technology or their licensed service provider for service by their technicians. Upon its return to Ridley Engineering, the RidleyBox will be reassembled, tested and returned to you.

# 11 Warranty Information

## 11.1 Limited Warranties

The RidleyBox houses multiple components, all of which are serviceable only by a licensed professional at Ridley Engineering Inc. There are no user-serviceable parts. Breaking the tamper-resistant seal on the RidleyBox or opening the case of the RidleyBox voids all warranties listed below.

The following list details the warranty period for each component. A charge may apply for services that are not covered by these warranties.

PicoScope 5444D Oscilloscope	5 years
Intel on-board Computer	3 years
Ridley Universal Injector	3 years

External Accessories manufactured by Ridley Engineering Inc.

Ridley Output Impedance	3 years
Ridley Impedance Test Kit	3 years
Ridley Line Injector	3 years
Differential Probes	1 year

RidleyWorks software is sold as a single-user lifetime license to the licensed user of the RidleyBox. The licensed user receives software updates at no additional expense. The frequency response analyzer function is software-based and is included in the license updates by the manufacturer.

Ridley Engineering's entire liability, and your sole and exclusive remedy for any defective or nonconforming component of the RidleyBox shall be, at Ridley's sole option: (a) repair or replacement of the defective or nonconforming component, or (b) return of the price you paid for the RidleyBox. Such remedy shall be available only during the applicable warranty period. Any repaired or replaced component shall be subject to the original warranty period, which shall not be extended due to such repair or replacement, except to the extent required by any mandatory, nonwaivable provision of applicable law.

THE FOREGOING WARRANTY IS EXCLUSIVE, AND RIDLEY ENGINEERING MAKES NO OTHER WARRANTIES OF ANY KIND WHATSOEVER, EXPRESS OR IMPLIED, AND RIDLEY ENGINEERING HEREBY EXPRESSLY DISCLAIMS ALL OTHER IMPLIED WARRANTIES OF MERCHANTABILITY AND FITNESS FOR A PARTICULAR USE OR PURPOSE. EXCEPT FOR THE REPLACEMENT OF ANY DEFECTIVE COMPONENT AS SET FORTH ABOVE, RIDLEY ENGINEERING SHALL HAVE NO LIABILITY, RESPONSIBILITY, OR OBLIGATION FOR ANY OTHER DAMAGES, CLAIMS, OR REMEDIES, INCLUDING, WITHOUT LIMITATION, ANY INCIDENTAL OR CONSEQUENTIAL DAMAGES FOR LOSS OF USE, REVENUE, OR PROFIT, OR FOR ANY OTHER DIRECT, INDIRECT, INCIDENTAL, SPECIAL OR CONSEQUENTIAL DAMAGES WHATSOEVER. RIDLEY ENGINEERING'S MAXIMUM LIABILITY FOR ANY AND ALL CLAIMS, LOSSES OR DAMAGES RESULTING FROM DEFECTIVE GOODS OR FROM ANY OTHER CAUSE WHATSOEVER, REGARDLESS OF THE FORM OF ACTION, WHETHER IN CONTRACT, TORT OR UNDER ANY PRODUCTS LIABILITY LAW, SHALL BE LIMITED TO THE PURCHASE PRICE PAID BY YOU FOR THE DEFECTIVE PRODUCT.

## 11.2 Warranty Exclusions

The above warranty on your RidleyBox will not apply to defects resulting from the following:

Customer-supplied software or interfacing

Damage by accident or abuse

Unauthorized modifications or misuse (see Sections 1.2-1.6)

Operation outside the environmental specifications listed in Section 1.6

Regarding your (end user's) particular purpose or usage of the RidleyBox, its hardware, software, firmware or components embodied in or used in conjunction with this product:

Ridley Engineering does not extend to you, the end user, any express warranty or any implied warranty of merchantability, fitness for use or fitness for any particular purpose.

Ridley Engineering is not responsible for any damages or loss, whether direct incidental or consequential, which you as the end user may experience as a result of your purchase or usage.